

Protection

Earth leakage protection

Acti9 Vigi iC60

Contents



Schneider Electric's range of add-on residual current devices consists of different products (A, B, C, D, E) to enable it to be the most competitive range possible in each country, allowing for the special characteristics of each market:

- usual installation procedure
- price
- accreditations by local bodies.

Variants

Offers	Catalogue numbers	Pages
Offer A	Catalogue numbers	2 and 10
Offer B	Catalogue numbers	5 and 10
Offer C	Catalogue numbers	9 and 10
Offer D Quick Vigi	Catalogue numbers	11 and 19
Offer E Quick Vigi	Catalogue numbers	15 and 19
Common pages		20

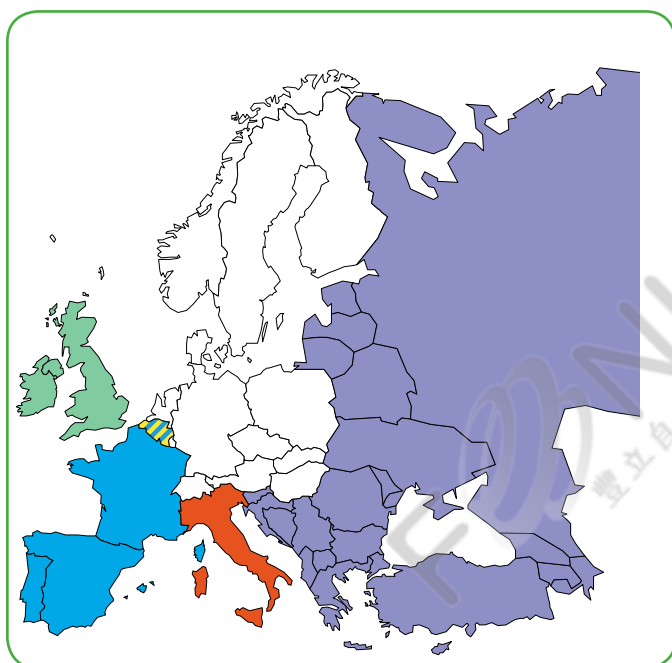

Only the product range to be marketed in your country and validated by the local product manager, in agreement with his Final Distribution (FD) partner should be retained. The others will be removed before publication.



Protection Earth leakage protection Acti9 Vigi iC60 add-on residual current devices (AC type)

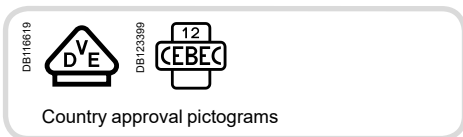

IEC/EN 61009-1

PB 104466-35

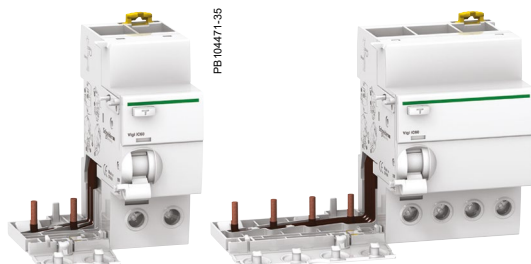

PB 104471-35

As per above standard:

- Combined with iC60 circuit breaker, the Vigi iC60 provide:
 - protection of persons against electric shock by direct contact (≤ 30 mA),
 - protection of persons against electric shock by indirect contact (≥ 100 mA),
 - protection of installations against the risk of fire (300 mA or 500 mA).

Catalogue numbers

Vigi iC60 add-on residual current devices for 230/400 V network										
Type	AC								Width in 9 mm modules	
Auxiliaries		Without auxiliaries								
2P		Sensitivity	10 mA	30 mA	100 mA	300 mA	500 mA	300 mA	1000 mA	
 DB122462	Rating	25 A	A9V10225	A9V11225	A9V12225	A9V14225	A9V16225	-	-	3
		40 A	-	A9V11240	-	A9V14240	A9V16240	-	-	4
		63 A	-	A9V11263	A9V12263	A9V14263	A9V16263	A9V15263	A9V19263	4
 DB122463	Rating	25 A	-	A9V11325	-	A9V14325	A9V16325	-	-	6
		40 A	-	A9V11340	-	A9V14340	A9V16340	-	-	7
		63 A	-	A9V11363	-	A9V14363	A9V16363	A9V15363	A9V19363	7
 DB122464	Rating	25 A	-	A9V11425	A9V12425	A9V14425	A9V16425	-	-	6
		40 A	-	A9V11440	-	A9V14440	A9V16440	-	-	7
		63 A	-	A9V11463	A9V12463	A9V14463	A9V16463	A9V15463	A9V19463	7
Voltage rating (Ue)	2P	230 - 240 V								
	3P-4P	400 - 415 V								
Operating frequency	50/60 Hz									
Accessories	Module CA907000									

Offer selection see page 1

Offer A

This sticker must be removed before publishing

Vigi iC60 add-on residual current devices for 110 V network											
Type	AC								Width in 9 mm modules		
Auxiliaries		Without auxiliaries									
2P		Sensitivity	30 mA	300 mA							
 DB122462	Rating	25 A	A9V01225	A9V04225							3
		40 A	A9V01240	A9V04240							4
		63 A	A9V01263	A9V04263							4
Voltage rating (Ue)	110 V										
Operating frequency	50/60 Hz										
Accessories	Module CA907000										

Protection Earth leakage protection Acti9 Vigi iC60 add-on residual current devices (A type)

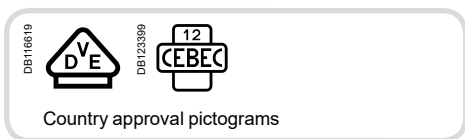

IEC/EN 61009-1

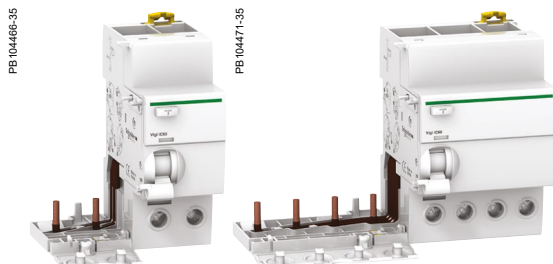

As per above standard:

- Combined with iC60 circuit breaker, the Vigi iC60 provide:
 - protection of persons against electric shock by direct contact (30 mA),
 - protection of persons against electric shock by indirect contact (≥ 100 mA),
 - protection of installations against the risk of fire (300 mA or 500 mA).

Catalogue numbers

Vigi iC60 add-on residual current devices for 230/400 V network								
Type	A							Width in 9 mm modules
Auxiliaries		Without auxiliaries						
2P		Sensitivity	30 mA	100 mA	300 mA	500 mA	300 mA	1000 mA
	Rating	25 A	A9V21225	A9V22225	A9V24225	A9V26225	-	-
		63 A	A9V21263	A9V22263	A9V24263	A9V26263	A9V25263	A9V29263
3P		Sensitivity	30 mA	100 mA	300 mA	500 mA	300 mA	1000 mA
	Rating	25 A	A9V21325	A9V22325	A9V24325	A9V26325	-	-
		63 A	A9V21363	-	A9V24363	A9V26363	A9V25363	A9V29363
4P		Sensitivity	30 mA	100 mA	300 mA	500 mA	300 mA	1000 mA
	Rating	25 A	A9V21425	A9V22425	A9V24425	A9V26425	-	-
		63 A	A9V21463	A9V22463	A9V24463	A9V26463	A9V25463	A9V29463
Voltage rating (Ue)	2P	230 - 240 V						
	3P-4P	400 - 415 V						
Operating frequency	50/60 Hz							
Accessories	Module CA907000							

Offer selection see page 1

Offer A

This sticker must be removed before publishing

Vigi iC60 add-on residual current devices for 400 V network				
Type	A			Width in 9 mm modules
Auxiliaries		Without auxiliaries		
2P		Sensitivity	30 mA	
	Rating	63 A	A9V07263	4
Voltage rating (Ue)	400 - 415 V			
Operating frequency	50/60 Hz			
Accessories	Module CA907000			

Protection Earth leakage protection

Acti9 Vigi iC60 add-on residual current devices (A-SI type)



IEC/EN 61009-1

As per above standard:

- Combined with iC60 circuit breaker, the Vigi iC60 provide:
 - protection of persons against electric shock by direct contact (≤ 30 mA),
 - protection of persons against electric shock by indirect contact (≥ 300 mA),
 - protection of installations against the risk of fire (300 mA).

The A-SI type provides increased immunity from electrical interference and polluted or corrosive environments.

Catalogue numbers

Vigi iC60 add-on residual current devices for 230/400 V network							
Type	A-SI					Width in 9 mm modules	
Auxiliaries	Without auxiliaries						
2P	Sensitivity	10 mA	30 mA	300 mA 	1000 mA 		
	Rating	25 A 40 A 63 A	A9V30225 - A9V31263	A9V31225 A9V31240 A9V35263	- - A9V39263	3 4 4	
3P	Sensitivity	10 mA	30 mA	300 mA 	1000 mA 		
	Rating	25 A 40 A 63 A	- A9V31325 A9V31363	A9V31325 A9V31340 A9V35363	- - A9V39363	6 7 7	
4P	Sensitivity	10 mA	30 mA	300 mA 	1000 mA 		
	Rating	25 A 40 A 63 A	- A9V31425 A9V31463	A9V31425 A9V31440 A9V35463	- - A9V39463	6 7 7	
Voltage rating (Ue)	2P	230 - 240 V					
	3P-4P	400 - 415 V					
Operating frequency	50/60 Hz						
Accessories	Module CA907000						

Vigi iC60 add-on residual current devices for 230 V network			
Type	A-SI		Width in 9 mm modules
Auxiliaries	Without auxiliaries		
3P	Sensitivity	30 mA	
	Rating	63 A	A9V71363 7
4P	Sensitivity	30 mA	
	Rating	63 A	A9V71463 7
Voltage rating (Ue)	230 V		
Operating frequency	50/60 Hz		
Accessories	Module CA907000		

Offer selection see page 1

Offer A

This sticker must be removed before publishing

Protection Earth leakage protection Acti9 Vigi iC60 add-on residual current devices (AC type)

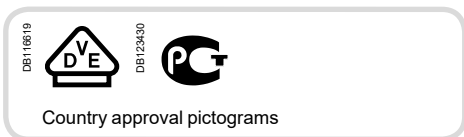

IEC/EN 61009-1



As per above standard:

- Combined with iC60 circuit breaker, the Vigi iC60 provide:
 - protection of persons against electric shock by direct contact (≤ 30 mA),
 - protection of persons against electric shock by indirect contact (≥ 100 mA),
 - protection of installations against the risk of fire (300 mA or 500 mA).

Catalogue numbers

Vigi iC60 add-on residual current devices for 230/400 V network										
Type	AC								Width in 9 mm modules	
Auxiliaries		Without auxiliaries								
2P		Sensitivity	10 mA	30 mA	100 mA	300 mA	500 mA	300 mA	1000 mA	
	Rating	25 A	A9V10225	A9V41225	A9V12225	A9V44225	A9V16225	-	-	3
		40 A	-	A9V41240	-	A9V44240	A9V16240	-	-	4
		63 A	-	A9V41263	A9V12263	A9V44263	A9V16263	A9V15263	A9V19263	4
	Rating	25 A	-	A9V41325	-	A9V44325	A9V16325	-	-	6
		40 A	-	A9V41340	-	A9V44340	A9V16340	-	-	7
		63 A	-	A9V41363	-	A9V44363	A9V16363	A9V15363	A9V19363	7
	Rating	25 A	-	A9V41425	A9V12425	A9V44425	A9V16425	-	-	6
		40 A	-	A9V41440	-	A9V44440	A9V16440	-	-	7
		63 A	-	A9V41463	A9V12463	A9V44463	A9V16463	A9V15463	A9V19463	7
Voltage rating (Ue)	2P	230 - 240 V								
	3P-4P	400 - 415 V								
Operating frequency	50/60 Hz									
Accessories	Module CA907000									

Offer selection see page 1

Offer B

This sticker must be removed before publishing

Protection

Earth leakage protection

Acti9 Vigi iC60 add-on residual current devices (AC type) (cont.)

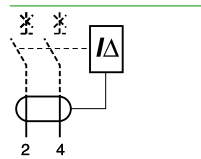
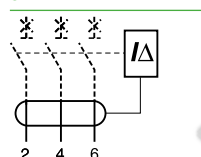
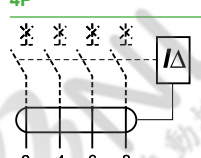
Vigi iC60 add-on residual current devices for 110/230 V network					
Type		AC 	Width in 9 mm modules		
Auxiliaries		Without auxiliaries			
2P 	Sensitivity	30 mA	300 mA		
	Rating	25 A	A9V01225	A9V04225	3
		40 A	A9V01240	A9V04240	4
		63 A	A9V01263	A9V04263	4
3P 	Sensitivity	30 mA	300 mA		
	Rating	25 A	A9V81325	-	6
		63 A	A9V81363	-	7
4P 	Sensitivity	30 mA	300 mA		
	Rating	25 A	A9V81425	-	6
		63 A	A9V81463	-	7
Voltage rating (Ue)	2P	110 V			
	3P-4P	230 V			
Operating frequency	50/60 Hz				
Accessories	Module CA907000				

Offer selection see page 1

Offer B

This sticker must be removed before publishing

Protection Earth leakage protection Acti9 Vigi iC60 add-on residual current devices (A type)

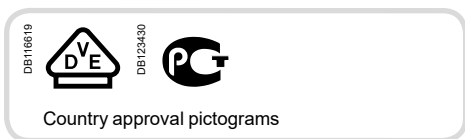

IEC/EN 61009-1

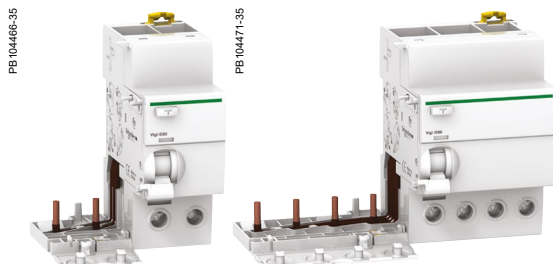

As per above standard:

- Combined with iC60 circuit breaker, the Vigi iC60 provide:
 - protection of persons against electric shock by direct contact (30 mA),
 - protection of persons against electric shock by indirect contact (≥ 100 mA),
 - protection of installations against the risk of fire (300 mA or 500 mA).

Catalogue numbers

Vigi iC60 add-on residual current devices for 230/400 V network								
Type	A							Width in 9 mm modules
Auxiliaries		Without auxiliaries						
2P		Sensitivity	30 mA	100 mA	300 mA	500 mA	300 mA	1000 mA
 DB122462	Rating	25 A	A9V51225	A9V22225	A9V54225	A9V26225	-	-
		63 A	A9V51263	A9V22263	A9V54263	A9V26263	A9V25263	A9V29263
3P		Sensitivity	30 mA	100 mA	300 mA	500 mA	300 mA	1000 mA
 DB122463	Rating	25 A	A9V51325	A9V22325	A9V54325	A9V26325	-	-
		63 A	A9V51363	-	A9V54363	A9V26363	A9V25363	A9V29363
4P		Sensitivity	30 mA	100 mA	300 mA	500 mA	300 mA	1000 mA
 DB122464	Rating	25 A	A9V51425	A9V22425	A9V54425	A9V26425	-	-
		63 A	A9V51463	A9V22463	A9V54463	A9V26463	A9V25463	A9V29463
Voltage rating (Ue)		2P	230 - 240 V					
		3P-4P	400 - 415 V					
Operating frequency		50/60 Hz						
Accessories		Module CA907000						

Offer selection see page 1

Offer B

This sticker must be removed before publishing

Vigi iC60 add-on residual current devices for 400 V network				
Type	A			Width in 9 mm modules
Auxiliaries		Without auxiliaries		
2P		Sensitivity	30 mA	
 DB122462	Rating	63 A	A9V07263	4
Voltage rating (Ue)		400 - 415 V		
Operating frequency		50/60 Hz		
Accessories		Module CA907000		

Protection Earth leakage protection

Acti9 Vigi iC60 add-on residual current devices (A-SI type)

IEC/EN 61009-1



Country approval pictograms

PB104466-3S

PB104471-3S

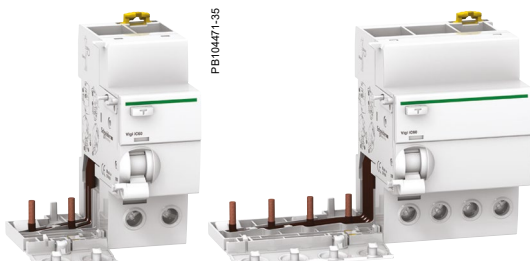

As per above standard:

- Combined with iC60 circuit breaker, the Vigi iC60 provide:
 - protection of persons against electric shock by direct contact (≤ 30 mA),
 - protection of persons against electric shock by indirect contact (≥ 300 mA),
 - protection of installations against the risk of fire (300 mA).

The A-SI type provides increased immunity from electrical interference and polluted or corrosive environments.

Catalogue numbers

Vigi iC60 add-on residual current devices for 230/400 V network						
Type	A-SI					Width in 9 mm modules
Auxiliaries	Without auxiliaries					
2P	Sensitivity	10 mA	30 mA	300 mA	1000 mA	
 DB122462	Rating	25 A	A9V30225	A9V61225	-	3
		40 A	-	A9V61240	-	4
		63 A	-	A9V61263	A9V65263	A9V39263
 DB122463	Rating	25 A	-	A9V61325	-	6
		40 A	-	A9V61340	-	7
		63 A	-	A9V61363	A9V65363	A9V39363
 DB122464	Rating	25 A	-	A9V61425	-	6
		40 A	-	A9V61440	-	7
		63 A	-	A9V61463	A9V65463	A9V39463
Voltage rating (Ue)	2P	230 - 240 V				
	3P-4P	400 - 415 V				
Operating frequency	50/60 Hz					
Accessories	Module CA907000					

Vigi iC60 add-on residual current devices for 230 V network							
Type	A-SI					Width in 9 mm modules	
Auxiliaries	Without auxiliaries						
3P	Sensitivity	30 mA					
 DB122462	Rating	63 A				A9V71363	7
 DB122462	Rating	63 A				A9V71463	7
Voltage rating (Ue)	230 V						
Operating frequency	50/60 Hz						
Accessories	Module CA907000						

Offer selection see page 1

Offer B

This sticker must be removed before publishing

Protection Earth leakage protection Acti9 Vigi iC60 add-on residual current devices (type A)

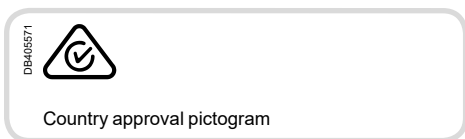

IEC/EN 61009-1

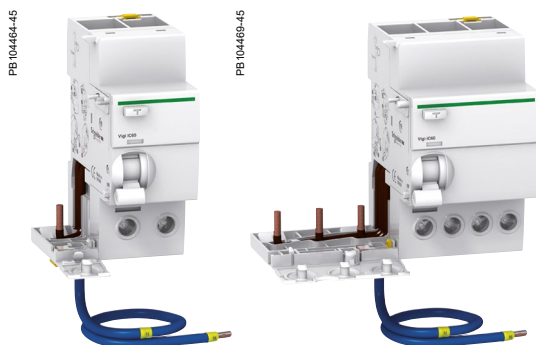

As per above standard:

- Combined with iC60 circuit breaker, the Vigi iC60 provide:
 - protection of persons against electric shock by direct contact (30 mA),
 - protection of persons against electric shock by indirect contact (≥ 100 mA),
 - protection of installations against the risk of fire (300 mA).

Catalogue numbers

Vigi iC60 add-on residual current devices for 230/400 V network					
Type	A				Width in 9 mm modules
Auxiliaries		Without auxiliaries			
2P		Sensitivity 30 mA		100 mA	300 mA
<p>DB122462</p>	Rating	63 A	A9V02663	A9V03663	A9V06663
					4 4
4P		Sensitivity 30 mA		100 mA	300 mA
<p>DB122464</p>	Rating	63 A	A9V02763	-	A9V06763
					6
Voltage rating (Ue)	2P	230 - 240 V			
	4P	400 - 415 V			
Operating frequency	50/60 Hz				
Accessories	Module CA907000				

Offer selection see page 1

Offer C

This sticker must be removed before publishing

Vigi iC60 add-on residual current devices for 110 V network					
Type	A				Width in 9 mm modules
Auxiliaries		Without auxiliaries			
2P		Sensitivity 30 mA		100 mA	300 mA
<p>DB122462</p>	Rating	63 A	A9V01663		4
Voltage rating (Ue)	110 V				
Operating frequency	50/60 Hz				
Accessories	Module CA907000				

Protection
Earth leakage protection

Acti9 Vigi iC60 add-on residual current devices
(AC, A, A-SI types) (cont.)

PB10456-51

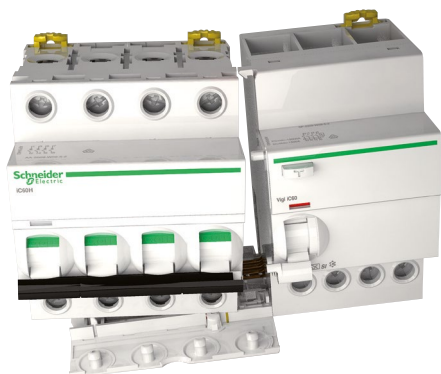

Association iC60a, N, H, L + Vigi iC60

iC60	Vigi iC60 25 A	Vigi iC60 40 A	Vigi iC60 63 A
0.5 A to 25 A	■	■	■
32 A - 40 A	NO	■	■
50 A - 63 A	NO	NO	■

Association iC60L-MA + Vigi iC60

iC60	Vigi iC60 25 A	Vigi iC60 40 A	Vigi iC60 63 A
1.6 A to 16 A	■	■	■
25 A	NO	■	■
40 A	NO	NO	■



Combining iC60 L-MA units with Vigi modules of higher rating.

Offer selection see page 1

Offer A, B, C

This sticker must be removed before publishing

PB 104466-40

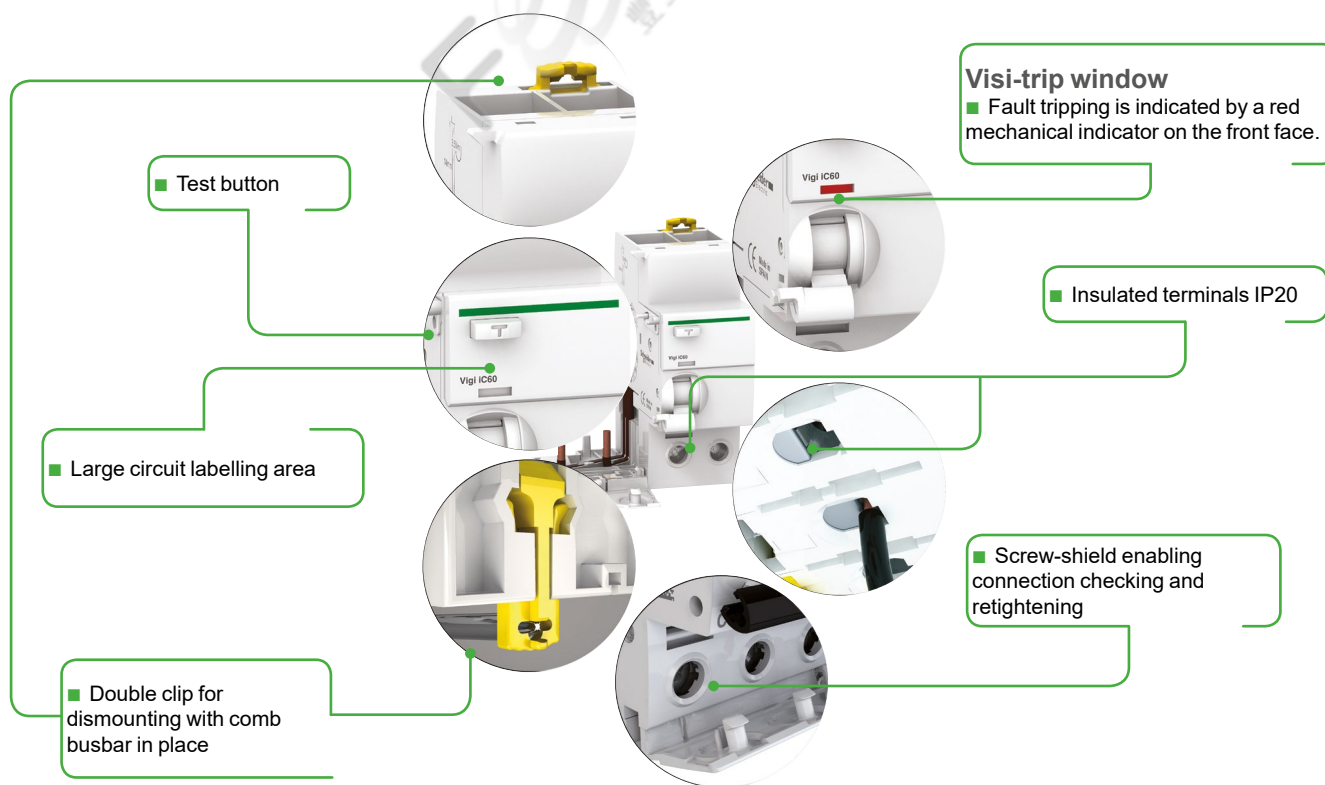

A-SI type

The A-SI type provides increased immunity from electrical interference and polluted or corrosive environments.

Protection Earth leakage protection Acti9 Vigi iC60 add-on residual current devices (AC type)



IEC/EN 61009-1

DB123811

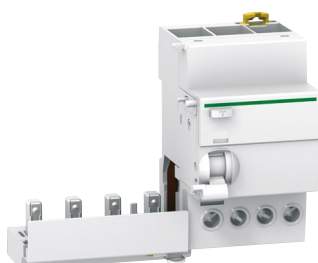

As per above standard:

- Combined with iC60 circuit breaker, the Vigi iC60 provide:
 - protection of persons against electric shock by direct contact (≤ 30 mA),
 - protection of persons against electric shock by indirect contact (≥ 100 mA),
 - protection of installations against the risk of fire (300 mA or 500 mA).

Catalogue numbers

Vigi iC60 add-on residual current devices for 230/400 V network										
Type	AC								Width in 9 mm modules	
Auxiliaries	Without auxiliaries									
2P	Sensitivity	10 mA	30 mA	100 mA	300 mA	500 mA	300 mA	1000 mA		
<p>DB122462</p>	Rating	25 A	A9Q10225	A9Q11225	A9Q12225	A9Q14225	A9Q16225	-	3	
		40 A	-	A9Q11240	-	A9Q14240	A9Q16240	-	4	
		63 A	-	A9V11263	A9V12263	A9V14263	A9V16263	A9V15263	A9V19263	4
<p>DB122463</p>	Rating	25 A	-	A9Q11325	-	A9Q14325	A9Q16325	-	6	
		40 A	-	A9Q11340	-	A9Q14340	A9Q16340	-	7	
		63 A	-	A9V11363	-	A9V14363	A9V16363	A9V15363	A9V19363	7
<p>DB122464</p>	Rating	25 A	-	A9Q11425	A9Q12425	A9Q14425	A9Q16425	-	6	
		40 A	-	A9Q11440	-	A9Q14440	A9Q16440	-	7	
		63 A	-	A9V11463	A9V12463	A9V14463	A9V16463	A9V15463	A9V19463	7
Voltage rating (Ue)	2P	230 - 240 V								
	3P-4P	400 - 415 V								
Operating frequency	50/60 Hz									
Accessories	Module CA907000									

Offer selection see page 1

Offer D Quick

This sticker must be removed before publishing

Protection

Earth leakage protection

Acti9 Vigi iC60 add-on residual current devices (AC type) (cont.)

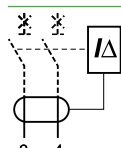
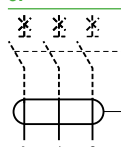
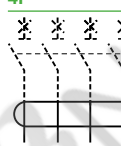
Vigi iC60 add-on residual current devices for 110/230 V network					
Type	AC 		Width in 9 mm modules		
Auxiliaries	Without auxiliaries				
	Sensitivity	30 mA	300 mA		
 DB1224G2	Rating	25 A	A9Q01225	A9Q04225	3
		40 A	A9Q01240	A9Q04240	4
		63 A	A9V01263	A9V04263	4
	Rating	25 A	A9Q81325	-	6
		63 A	A9V81363	-	7
	Rating	25 A	A9Q81425	-	6
		63 A	A9V81463	-	7
Voltage rating (Ue)		2P	110 V		
		3P-4P	230 V		
Operating frequency		50/60 Hz			
Accessoires		Module CA907000			

Offer selection see page 1

Offer D Quick

This sticker must be removed before publishing

Protection Earth leakage protection

Acti9 Vigi iC60 add-on residual current devices (A type)

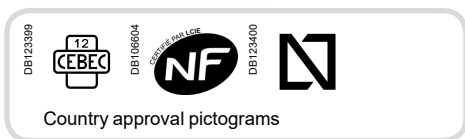

IEC/EN 61009-1

DB123811



As per above standard:

- Combined with iC60 circuit breaker, the Vigi iC60 provide:
 - protection of persons against electric shock by direct contact (30 mA),
 - protection of persons against electric shock by indirect contact (≥ 100 mA),
 - protection of installations against the risk of fire (300 mA or 500 mA).

Catalogue numbers

Vigi iC60 add-on residual current devices for 230/400 V network									
Type	A							Width in 9 mm modules	
Auxiliaries	Without auxiliaries								
2P	Sensitivity	30 mA	100 mA	300 mA	500 mA	300 mA	1000 mA		
 DB12462	Rating	25 A	A9Q21225	A9Q22225	A9Q24225	A9Q26225	-	3	
		63 A	A9V21263	A9V22263	A9V24263	A9V26263	A9V25263	A9V29263	4
 DB12463	Rating	25 A	A9Q21325	A9Q22325	A9Q24325	A9Q26325	-	6	
		63 A	A9V21363	-	A9V24363	A9V26363	A9V25363	A9V29363	7
 DB12464	Rating	25 A	A9Q21425	A9Q22425	A9Q24425	A9Q26425	-	6	
		63 A	A9V21463	A9V22463	A9V24463	A9V26463	A9V25463	A9V29463	7
Voltage rating (Ue)	2P	230 - 240 V							
	3P-4P	400 - 415 V							
Operating frequency	50/60 Hz								
Accessories	Module CA907000								

Offer selection see page 1

Offer D Quick

This sticker must be removed before publishing

Protection

Earth leakage protection

Acti9 Vigi iC60 add-on residual current devices (A-SI type)



IEC/EN 61009-1

As per above standard:

- Combined with iC60 circuit breaker, the Vigi iC60 provide:
 - protection of persons against electric shock by direct contact (≤ 30 mA),
 - protection of persons against electric shock by indirect contact (≥ 300 mA),
 - protection of installations against the risk of fire (300 mA).

The A-SI type provides increased immunity from electrical interference and polluted or corrosive environments.

Catalogue numbers

Vigi iC60 add-on residual current devices for 230/400 V network

Type	A-SI		Width in 9 mm modules			
Auxiliaries	Without auxiliaries					
2P	Sensitivity	10 mA	30 mA	300 mA	1000 mA	
 DB122462	Rating	25 A	A9Q31225	A9Q31225	-	3
		40 A	-	A9Q31240	-	4
		63 A	-	A9V31263	A9V35263	4
3P	Sensitivity	10 mA	30 mA	300 mA	1000 mA	
 DB122463	Rating	25 A	-	A9Q31325	-	6
		40 A	-	A9Q31340	-	7
		63 A	-	A9V31363	A9V35363	7
4P	Sensitivity	10 mA	30 mA	300 mA	1000 mA	
 DB122464	Rating	25 A	-	A9Q31425	-	6
		40 A	-	A9Q31440	-	7
		63 A	-	A9V31463	A9V35463	7
Voltage rating (Ue)	2P	230 - 240 V				
	3P-4P	400 - 415 V				
Operating frequency	50/60 Hz					
Accessories	Module CA907000					

Vigi iC60 add-on residual current devices for 230 V network

Type	A-SI		Width in 9 mm modules	
Auxiliaries	Without auxiliaries			
3P	Sensitivity	30 mA		
 DB122462	Rating	63 A	A9V71363	7
4P	Sensitivity	30 mA		
 DB122464	Rating	63 A	A9V71463	7
Voltage rating (Ue)	230 V			
Operating frequency	50/60 Hz			
Accessories	Module CA907000			

Offer selection see page 1

Offer D Quick

This sticker must be removed before publishing

Protection Earth leakage protection

Acti9 Vigi iC60 add-on residual current devices (AC type)

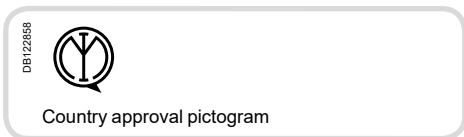

IEC/EN 61009-1

DB122811



As per above standard:

- Combined with iC60 circuit breaker, the Vigi iC60 provide:
 - protection of persons against electric shock by direct contact (≤ 30 mA),
 - protection of persons against electric shock by indirect contact (≥ 100 mA),
 - protection of installations against the risk of fire (300 mA or 500 mA).

Catalogue numbers

Vigi iC60 add-on residual current devices for 230/400 V network										
Type	AC								Width in 9 mm modules	
Auxiliaries	Without auxiliaries									
2P	Sensitivity	10 mA	30 mA	100 mA	300 mA	500 mA	300 mA	1000 mA		
	Rating	25 A	A9Q41225	A9Q12225	A9Q44225	A9Q16225	-	-	3	
		40 A	A9Q41240	-	A9Q44240	A9Q16240	-	-	4	
		63 A	A9V41263	A9V12263	A9V44263	A9V16263	A9V15263	A9V19263	4	
	Rating	25 A	A9Q41325	-	A9Q44325	A9Q16325	-	-	6	
		40 A	A9Q41340	-	A9Q44340	A9Q16340	-	-	7	
		63 A	A9V41363	-	A9V44363	A9V16363	A9V15363	A9V19363	7	
	Rating	25 A	A9Q41425	A9Q12425	A9Q44425	A9Q16425	-	-	6	
		40 A	A9Q41440	-	A9Q44440	A9Q16440	-	-	7	
		63 A	A9V41463	A9V12463	A9V44463	A9V16463	A9V15463	A9V19463	7	
Voltage rating (Ue)	2P	230 - 240 V								
	3P-4P	400 - 415 V								
Operating frequency	50/60 Hz									
Accessories	Module CA907000									

Offer selection see page 1

Offer E Quick

This sticker must be removed before publishing

Acti9 Vigi iC60 add-on residual current devices (AC type) (cont.)

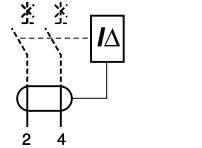
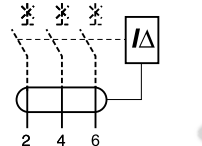
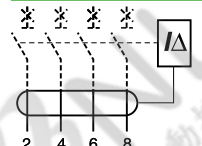
Vigi iC60 add-on residual current devices for 110/230 V network					
Type	AC 		Width in 9 mm modules		
Auxiliaries	Without auxiliaries				
2P	Sensitivity	30 mA	300 mA		
 <small>DB1224G2</small>	Rating	25 A	A9Q01225	A9Q04225	3
		40 A	A9Q01240	A9Q04240	4
		63 A	A9Q01263	A9Q04263	4
3P	Sensitivity	30 mA	300 mA		
	Rating	25 A	A9Q81325	-	6
		63 A	A9V81363	-	7
4P	Sensitivity	30 mA	300 mA		
	Rating	25 A	A9Q81425	-	6
		63 A	A9V81463	-	7
Voltage rating (Ue)		2P	110 V		
		3P-4P	230 V		
Operating frequency		50/60 Hz			
Accessoires		Module CA907000			

Offer selection see page 1

Offer E Quick

This sticker must be removed before publishing

Protection Earth leakage protection Acti9 Vigi iC60 add-on residual current devices (A type)

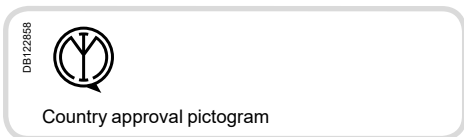

IEC/EN 61009-1

DB123811



As per above standard:

- Combined with iC60 circuit breaker, the Vigi iC60 provide:
 - protection of persons against electric shock by direct contact (30 mA),
 - protection of persons against electric shock by indirect contact (≥ 100 mA),
 - protection of installations against the risk of fire (300 mA or 500 mA).

Offer selection see page 1

Offer E Quick

This sticker must be removed before publishing

Catalogue numbers

Vigi iC60 add-on residual current devices for 230/400 V network									
Type	A							Width in 9 mm modules	
Auxiliaries	Without auxiliaries								
2P	Sensitivity	30 mA	100 mA	300 mA	500 mA	300 mA	1000 mA		
 DB122462	Rating	25 A	A9Q51225	A9Q22225	A9Q54225	A9Q26225	-	3	
		63 A	A9V51263	A9V22263	A9V54263	A9V26263	A9V25263	A9V29263	4
 DB122463	Rating	25 A	A9Q51325	A9Q22325	A9Q54325	A9Q26325	-	6	
		63 A	A9V51363	-	A9V54363	A9V26363	A9V25363	A9V29363	7
 DB122464	Rating	25 A	A9Q51425	A9Q22425	A9Q54425	A9Q26425	-	6	
		63 A	A9V51463	A9V22463	A9V54463	A9V26463	A9V25463	A9V29463	7
Voltage rating (Ue)	2P	230 - 240 V,							
	3P-4P	400 - 415 V							
Operating frequency	50/60 Hz								
Accessories	Module CA907000								

Protection Earth leakage protection

Acti9 Vigi iC60 add-on residual current devices (A-SI type)

IEC/EN 61009-1

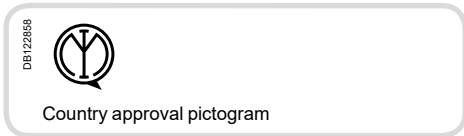

DB123811

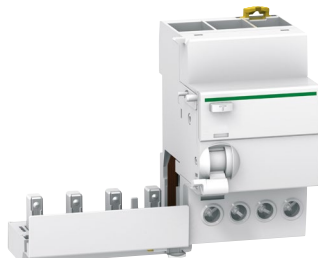

As per above standard:

- Combined with iC60 circuit breaker, the Vigi iC60 provide:
 - protection of persons against electric shock by direct contact (≤ 30 mA),
 - protection of persons against electric shock by indirect contact (≥ 300 mA),
 - protection of installations against the risk of fire (300 mA).

The A-SI type provides increased immunity from electrical interference and polluted or corrosive environments.

Catalogue numbers

Vigi iC60 add-on residual current devices for 230/400 V network						
Type	A-SI					Width in 9 mm modules
Auxiliaries		Without auxiliaries				
Sensitivity		10 mA	30 mA	300 mA	1000 mA	
DB122462 	Rating	25 A	A9Q30225	A9Q61225	-	3
		40 A	-	A9Q61240	-	4
		63 A	-	A9V61263	A9V65263	A9V39263
DB122463 	Rating	25 A	-	A9Q61325	-	6
		40 A	-	A9Q61340	-	7
		63 A	-	A9V61363	A9V65363	A9V39363
DB122464 	Rating	25 A	-	A9Q61425	-	6
		40 A	-	A9Q61440	-	7
		63 A	-	A9V61463	A9V65463	A9V39463
Voltage rating (Ue)	2P	230 - 240 V				
	3P-4P	400 - 415 V				
Operating frequency	50/60 Hz					
Accessories	Module CA907000					

Vigi iC60 add-on residual current devices for 230 V network			
Type	A-SI		Width in 9 mm modules
Auxiliaries		Without auxiliaries	
Sensitivity		30 mA	
DB122462 	Rating	63 A	A9V71363
DB122464 	Rating	63 A	A9V71463
Voltage rating (Ue)	230 V		
Operating frequency	50/60 Hz		
Accessories	Module CA907000		

Offer selection see page 1

Offer E Quick

This sticker must be removed before publishing

Protection

Earth leakage protection

Acti9 Vigi iC60 add-on residual current devices (AC, A, A-SI types) (cont.)

DE123612

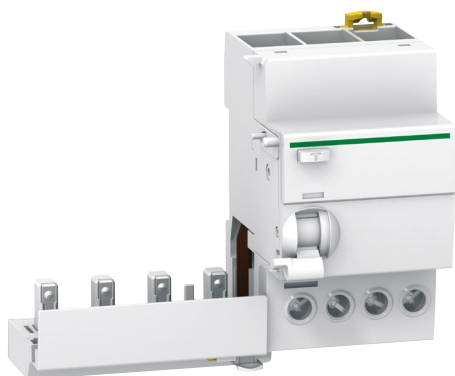

Association iC60a, N, H, L + Vigi iC60

iC60	Vigi iC60 25 A	Vigi iC60 40 A	Vigi iC60 63 A
0.5 A to 25 A	■	■	■
32 A - 40 A	NO	■	■
50 A - 63 A	NO	NO	■

Association iC60L-MA + Vigi iC60

iC60	Vigi iC60 25 A	Vigi iC60 40 A	Vigi iC60 63 A
1.6 A to 16 A	■	■	■
25 A	NO	■	■
40 A	NO	NO	■



Combining iC60 L-MA units with Vigi modules of higher rating.

Offer selection see page 1

Offer D, E Quick

This sticker must be removed before publishing

DE123515

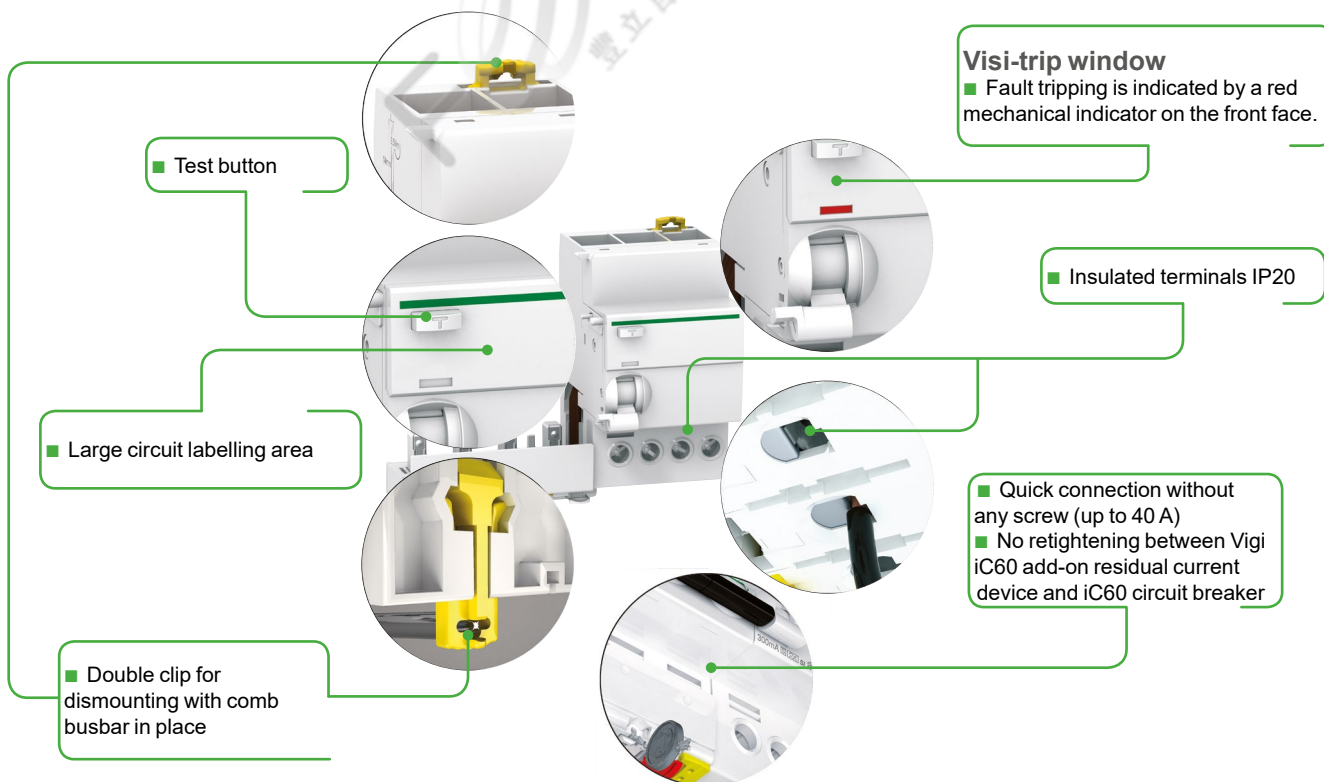

A-SI type

The A-SI type provides increased immunity from electrical interference and polluted or corrosive environments.

Protection Earth leakage protection

Acti9 Vigi iC60 add-on residual current devices (AC, A, A-SI types) (cont.)

Connection

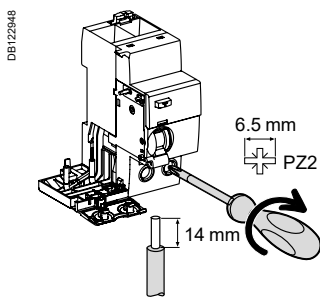

Type	Rating	Tightening torque	Copper cables	
			Rigid	Flexible or with ferrule
Vigi iC60	25 A	2 N.m	1 to 25 mm ²	1 to 16 mm ²
	40 to 63 A	3.5 N.m	1 to 35 mm ²	1 to 25 mm ²

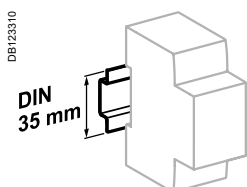



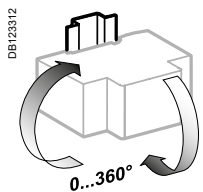

Clip on DIN rail 35 mm.

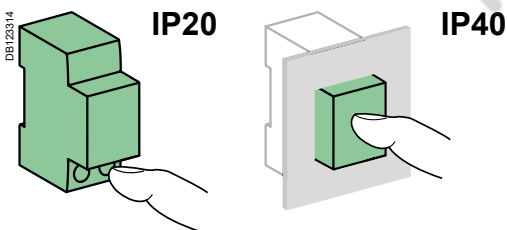

Indifferent position of installation.



Technical data

Main characteristics		
Insulation voltage (U _i)		500 V
Pollution degree		3
Rated impulse withstand voltage (U _{imp})		6 kV
According to IEC/EN 61009-1		
Surge current withstand (8/20 μs) without tripping	AC and A types (no selective )	250 Å
	AC, A types (selective )	3 kÅ
	A-SI type	3 kÅ
Behaviour in case of voltage drop		Residual current protection down to 0 V according to IEC/EN 61009-1 § 3.3.8
Additional characteristics		
Degree of protection	Device only	IP20
	Device in modular enclosure	IP40 Insulation class II
Operating temperature	AC type	-5°C to +60°C
	A and A-SI types	 -25°C to +60°C
Storage temperature		-40°C to +85°C

Protection

Earth leakage protection

Acti9 Vigi iC60 add-on residual current devices (AC, A, A-SI types) (cont.)

Weight (g)

Add-on residual current devices	
Type	Vigi iC60
2P	165
3P	210
4P	245

Dimensions (mm)

Vigi iC60 25 A

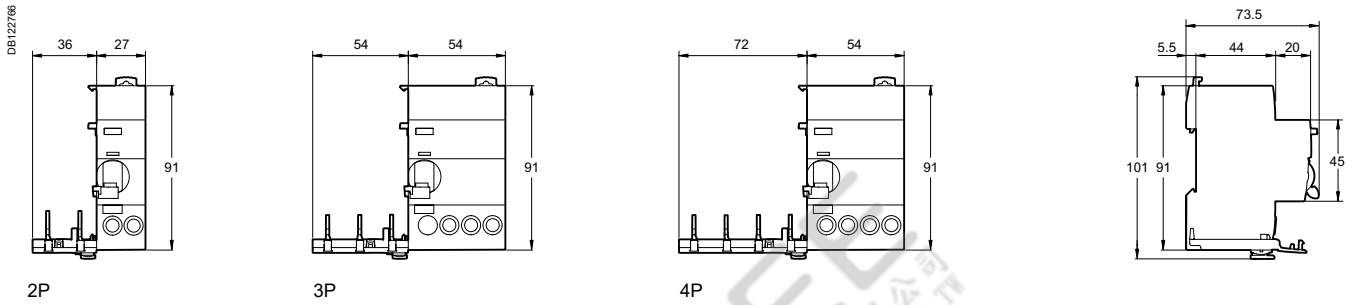

Vigi iC60 40 and 63 A

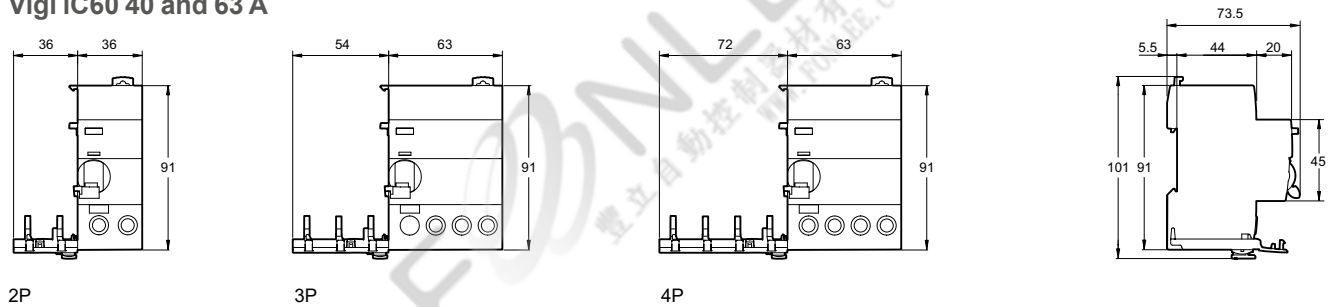

Acti9 Vigi iC60 add-on residual current devices
(AC, A, A-SI types) (cont.)

FOONLEE
豐立自動控制器材有限公司
www.FOONLEE.COM.TW

Indice	Date	Modification	Name
5.3	19/02/2020	Change width of A9V02763 and A9V06763 from 7 to 6 modules of 9 mm	I. Flaubert
5.2	06/10/2017	Added 2P, 3P and 4P 110/230 V products, pages 6-12-14-16-18	Sonovision
5.1	17/09/2017	Added 3P and 4P 230 V products, pages 4-6-8-12-16	Sonovision
5.0	21/03/2017	New charte	Sonovision
4.6	5/01/2016	Added 2P, 3P-4P line tables for Ue	Sonovision
4.5	25/03/2015	Deleted "IEC/EN 61009-2-1: Voltage Independent" - Changed VIT text in Technical data table	Sonovision
4.4	8/04/2014	Changed 130 V to 110 V	Sedoc
4.3	17/03/2014	Add 2P A type 400 V products for Offer A and B	Sedoc
4.2	14/01/2014	Add Voltage Independent -	Sedoc
4.1	12/02/2013	Deleted A type, 10 mA product offer C page 8	Sedoc
4.0	22/08/2012	Add Offer C photos page 8	Sedoc
3.3	27/06/2012	Add Vigi Disbo C offer page 8 - Change C Quick and D Quick offers to D Quick and E Quick offers	Sedoc
3.2	28/03/2012	Deleted IEC60947 in technical data table	Sedoc
3.1	20/09/2011	"A si" change in "SI"	Sedoc
3.0	19/05/2011	InDesign CS5	Sedoc
2.5	23/03/2011	Change color yellow to blue: Offer C Quick Vigi in the table page 1	Sedoc
2.4	15/12/2010	Change iC60L-MA association table, page 16 and 17	Sedoc