

## ■ 特性

- 操控方式、把手、面板多樣化。
- 獨創接點座模組化，拆換接點座時內部零件不致分解四散。
- 接點座可以自行組裝及拆卸，可降低客戶因機種過多的庫存。
- 接點座可依需要加裝，方便的卡式固定，不需拆鎖螺絲。
- 接線螺絲由一般的側鎖式改為後鎖式，方便客戶配線。
- 將接線端子及螺絲設計在接點座內部，可保護使用者不致誤觸電源。
- 所有端子的連接片皆以護蓋保護，避免誤觸電源。
- 容量以接點座顏色區分，10A為藍色，16A為灰色，25A為黑色。



## ■ 規格

電壓	容量		AC-3(kw)		AC-23A(kw)		AC-21A Iu=Ith	額定電壓	AC-3(HP)		馬達負載
	3 ph.	1 ph.	3 ph.	1 ph.	3 ph.	1 ph.			3 ph.	1 ph.	
220V~240V	1.5	0.55	1.8	0.75	10A	120V	0.75	0.33	10A		
380V~440V	2.2	0.75	3	1.1							
660V~690V	2.2	0.75	3	1.1							
220V~240V	3	1.5	4	2.2	16A	120V	1.5	0.5	16A		
380V~440V	5.5	2.2	7	3							
660V~690V	5.5	2.2	7	3							
220V~240V	4	3	5.5	3	25A	120V	3	1.5	25A		
380V~440V	7.5	3.7	11	5.5							
660V~690V	7.5	3.7	11	5.5							

IEC 60947-3, EN 60947-3

VDE 0660 part 107

HD A300

UL 77B7

## ■ 組立圖

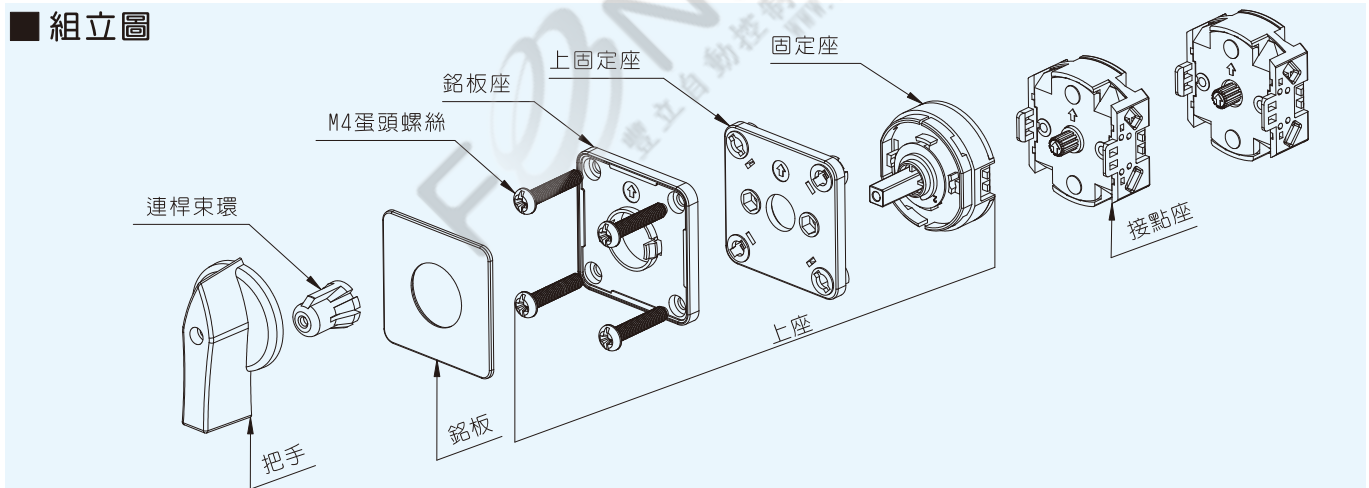

## ■ 48面板與64面板二系列，由把手、銘板、上座與接點座組成，可自行拆組。

- 上座與接點座之裝卸，接點座與接點座之裝卸。

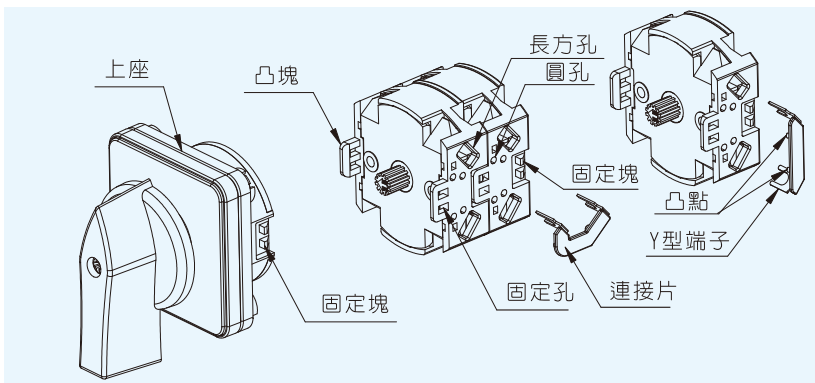

- 上座與接點座裝配: 上座凸起之固定塊對準接點座之固定孔推入即可。
- 接點座與接點座裝配: 接點座凸起之固定塊對準接點座之固定孔推入即可。
- 拆卸: 以一字起子(螺絲刀), 分別插入接點座之凸塊往上撬起, 即可拆卸。
- 連接片組裝: 將連接片上的Y型端子插入接點座兩側之長方形孔, 並將連接片上的凸點壓入接點座上的圓孔即可。

## 型號說明

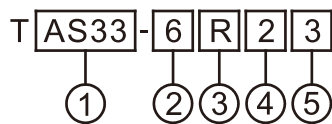

項次	代號	說明
1. 控制型式	AS33	電流切換開關 (三相三線)
	AS34	電流切換開關 (三相四線)
	VS33	電壓切換開關 (三相三線)
	VS34	電壓切換開關 (三相四線)
	VS334	電壓切換開關 (三相三線) (三相四線)
	AV33	電壓電流切換開關 (三相三線)

2. 外型	4	48*48
	6	64*64
3. 面板及把手顏色	空白	銀面板黑把手
	R	黃面板紅把手
4. 容量	1	10A
	2	16A
	3	25A
5. 比流器數量	空白	2CT
	3	3CT

## 外觀尺寸

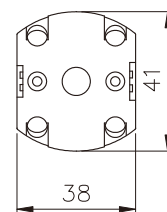
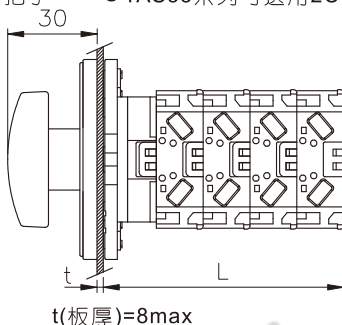
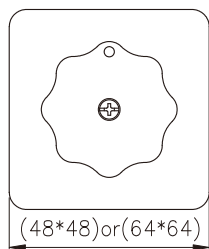
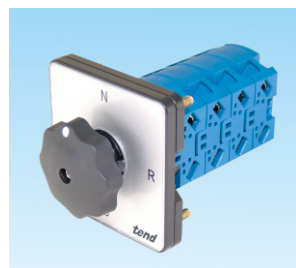

層數	L
一層	32
兩層	47
三層	62
四層	77
五層	92
六層	107

● 本系列開關全部為八角把手。 ● TAS33系列可選用2CT或3CT。

t(板厚)=8max

## 面板、接點圖及接線圖

### TAS33-□□

AS(3Ø3W 2CT)

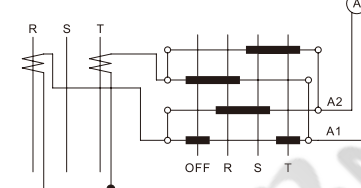
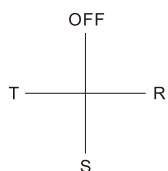

### TVS33-□□

VS(3Ø3W)

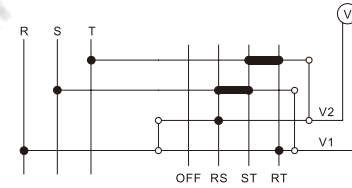
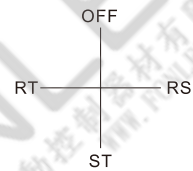

### TAS33-□□3

AS(3Ø3W 3CT)

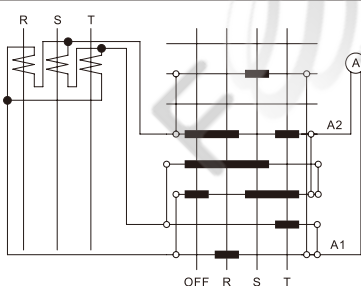
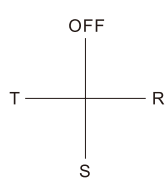

### TVS34-□□

VS(3Ø4W)

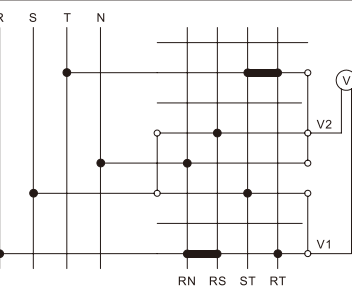
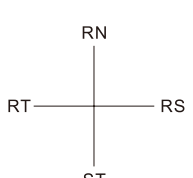

### TAS34-□□

AS(3Ø4W 3CT)

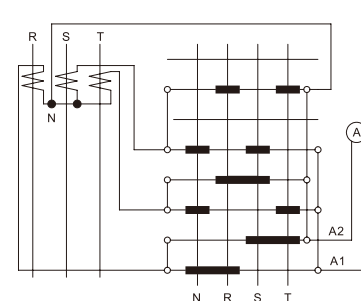
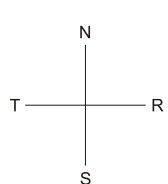

### TAV33-□□

AS(3Ø3W 2CT)  
VS(3Ø3W)

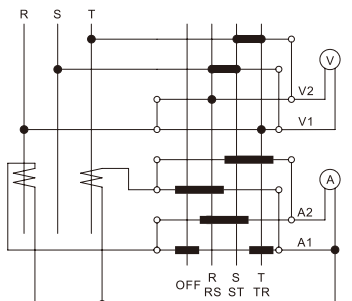
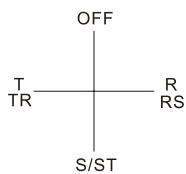

### TVS334-□□

VS(3Ø3W)  
VS(3Ø4W)

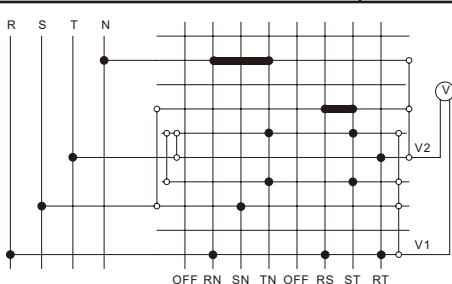
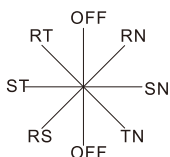

## 型號說明

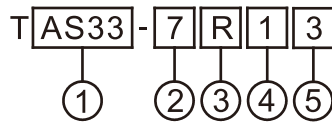

項次	代號	說明	2.外型	5	48*60
1.控制型式	AS33	電流切換開關 (三相三線)	7		64*80
	AS34	電流切換開關 (三相四線)	3.面板及把手顏色	空白	銀面板黑把手 黃面板紅把手
	VS33	電壓切換開關 (三相三線)	4.容量	1	10A
	VS34	電壓切換開關 (三相四線)	2	16A	
	VS334	電壓切換開關 (三相三線) (三相四線)	3	25A	
	AV33	電壓電流切換開關 (三相三線)	5.比流器數量	空白	2CT
			3	3CT	

● 本系列開關全部為八角把手。 ● TAS33系列可選用2CT或3CT。

## 外觀尺寸

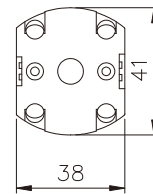
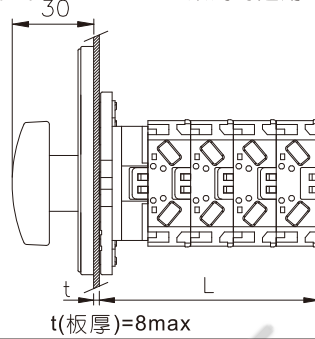
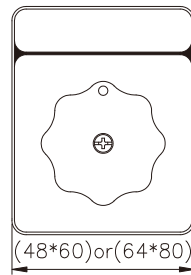

層數	L
一層	32
兩層	47
三層	62
四層	77
五層	92
六層	107

## 面板、接點圖及接線圖

### TAS33-□□

AS(3Ø3W 2CT)

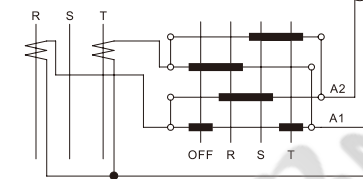
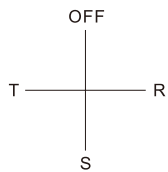

### TVS33-□□

VS(3Ø3W)

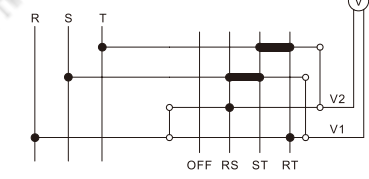
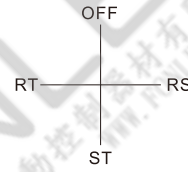

### TAS33-□□3

AS(3Ø3W 3CT)

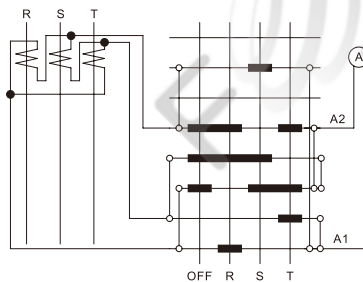
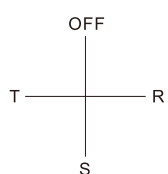

### TVS34-□□

VS(3Ø4W)

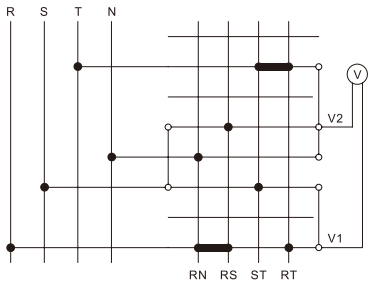
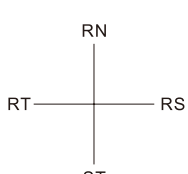

### TAS34-□□

AS(3Ø4W 3CT)

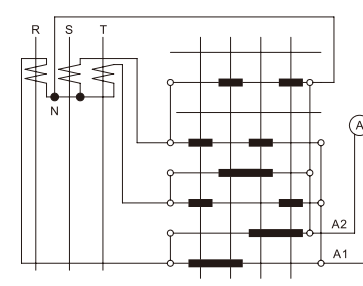
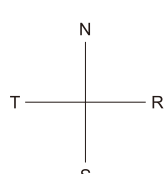

### TAV33-□□

AS(3Ø3W 2CT)  
VS(3Ø3W)

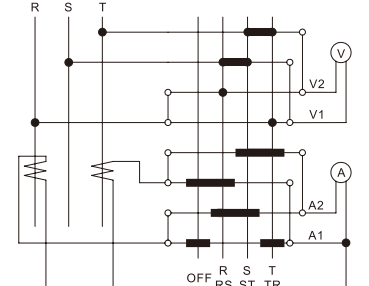
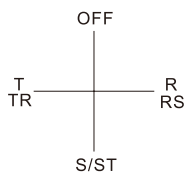

### TVS334-□□

VS(3Ø3W)  
VS(3Ø4W)

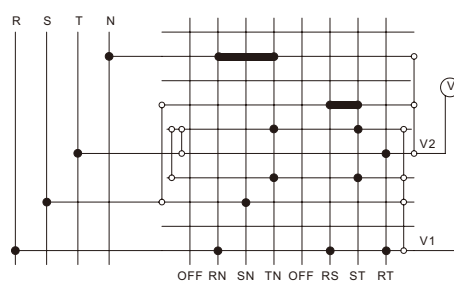
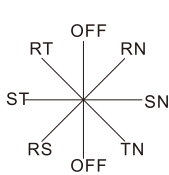

■ 客戶訂購成品，型號請參閱本頁之成品型號說明。

## ■ 成品型號說明

TCS 4 S R 242 - 2 2209 R

1  
 2  
 3  
 4  
 5  
 6  
 7

項次	代號	說明
1.外形	4	48*48
	6	64*64
2.把手	S	短把手
	L	長把手
	O	八角把手
3.面板及把手顏色	空白	銀面板黑把手
	R	黃面板紅把手

4.段數、度數、銘板編號	240~842	見TA23頁
5.容量	1	10A
	2	16A
	3	25A
6.接線圖號		見TA22~TA33頁
7.動作特性 (限45°2段、3段用)	空白	保持
	R	復歸(90°無復歸)

## ■ 外觀尺寸

TCS4S   -      

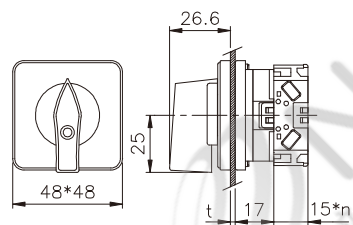

t(板厚)=6max n=p數

TCS6S   -      

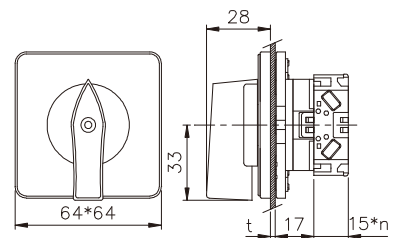

t(板厚)=8max n=p數

TCS4L   -      

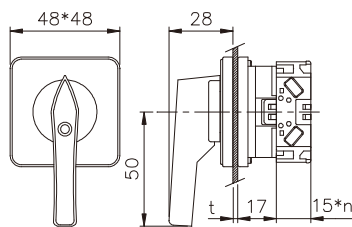

t(板厚)=6max n=p數

TCS6L   -      

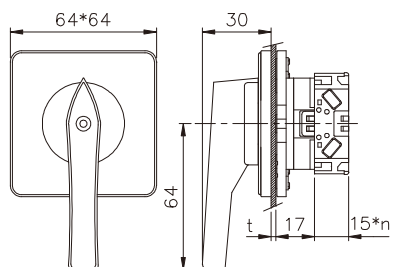

t(板厚)=8max n=p數

TCS4O   -      

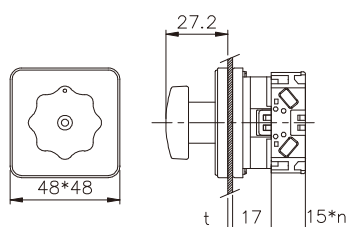

t(板厚)=8max n=p數

TCS6O   -      

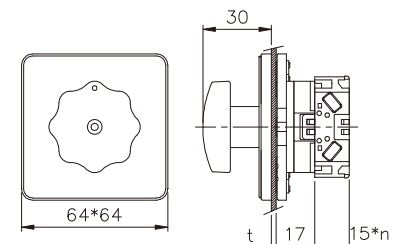

t(板厚)=8max n=p數



■ 客戶訂購成品，型號請參閱本頁之成品型號說明。

## ■ 成品型號說明

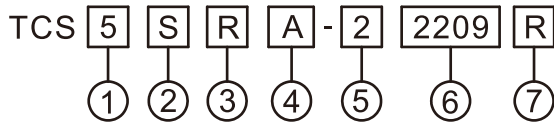

項次	代號	說明
1.外形	5	48*60
	7	64*80
2.把手	S	短把手
	L	長把手
	O	八角把手
3.面板及把手顏色	空白	銀面板黑把手
	R	黃面板紅把手

4.長銘板編號	A~Z	見TA20頁
5.容量	1	10A
	2	16A
	3	25A
6.接線圖號		見TA22~TA33頁
7.動作特性 (限45°2段、3段用)	空白	保持
	R	復歸(90°無復歸)

## ■ 外觀尺寸

TCS5S□□-□□□

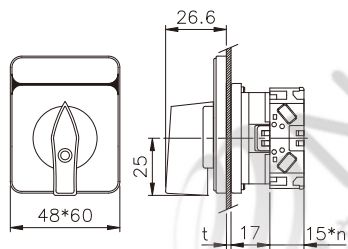

t(板厚)=6max n=p數

TCS7S□□-□□□

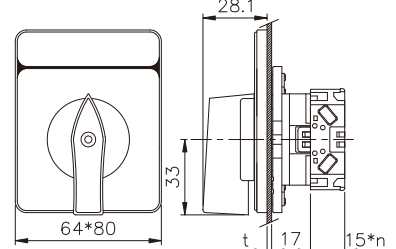

t(板厚)=8max n=p數

TCS5L□□-□□□

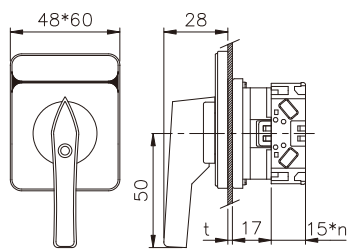

t(板厚)=6max n=p數

TCS7L□□-□□□

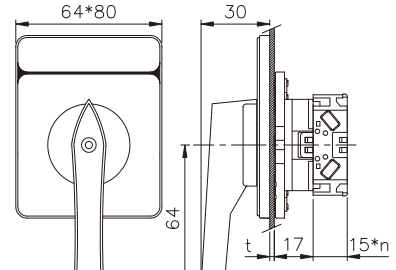

t(板厚)=8max n=p數

TCS5O□□-□□□

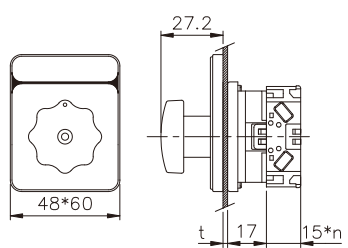
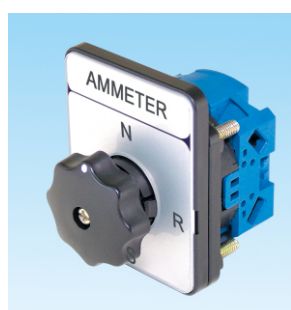

t(板厚)=8max n=p數

TCS7O□□-□□□

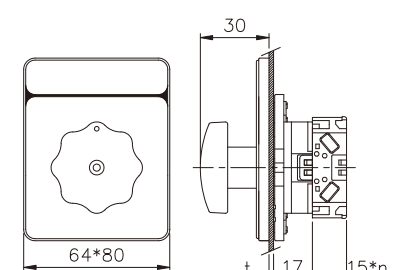

t(板厚)=8max n=p數

■ 訂購組件自行組裝,請參閱下圖組裝示意圖及TA21,22,23頁上的組件型號說明。

● 48\*48與64\*64系列組件

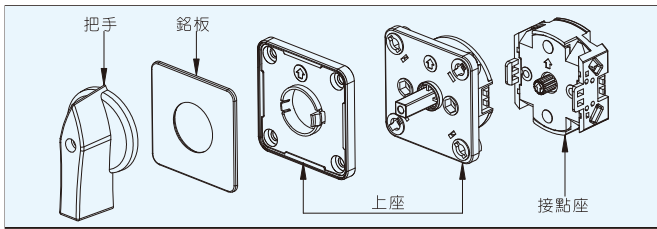

● 48\*60與64\*80系列組件

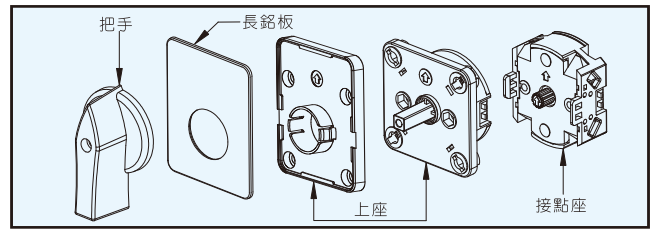

## ■ 把手型號說明

TCS 4 S R  
1 2 3

項次	代號	說明
1.外形	4	48*48與64*80面板用
	6	64*64與64*80面板用

2.把手	S	短把手
	L	長把手
	O	八角把手
3.把手顏色	B	黑色
	R	紅色

## ■ 外觀尺寸

### TCS4S

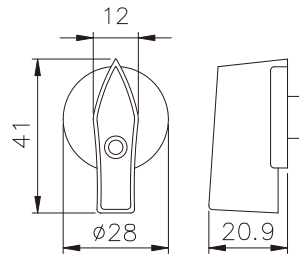

### TCS6S

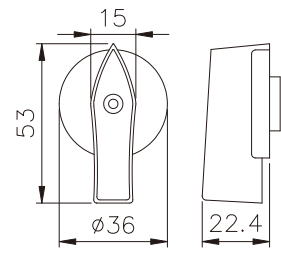
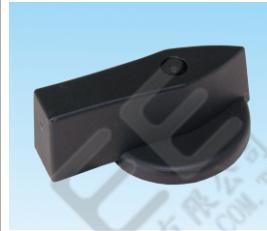

### TCS4L

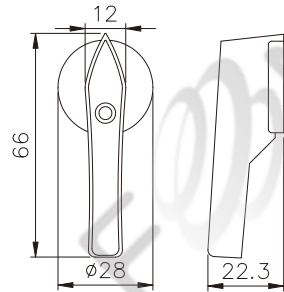

### TCS6L

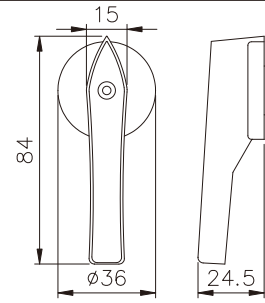
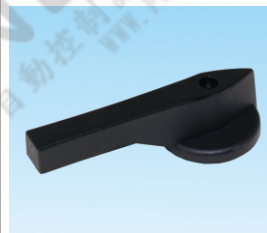

### TCS4O

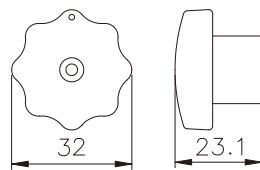

### TCS6O

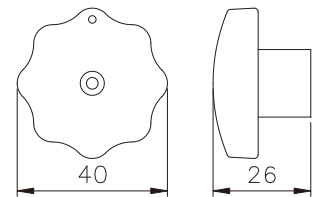
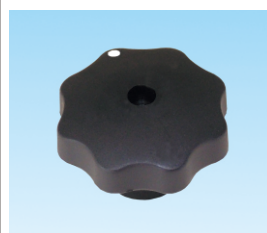

## ■ 接點座型號說明

TCS 1 C 01  
1 2 3

項次	代號	說明
1.容量	1	10A
	2	16A
	3	25A
2.接點數量	S	單接點
	C	雙接點
3.接點座編號	01~A1	見TA22~TA33頁

## ■ 外觀尺寸

TCS□-C01~CA1  
 TCS□-S01~SA1

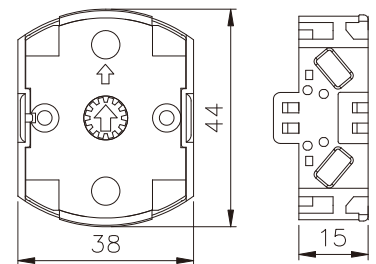
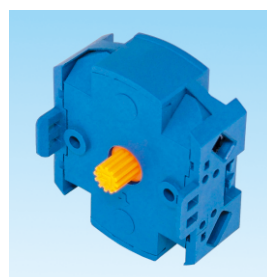

## ■上座型號說明

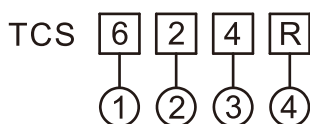

項次	代號	說明
1. 形狀	4	48*48
	5	48*60
	6	64*64
	7	64*80
2. 段數	2~8	2~8段
3. 度數	4	45°
	9	90°
4. 動作特性 (限45°2段、3段用)	空白	保持
	R	復歸(90°無復歸)

## ■外觀尺寸與裝配孔徑

TCS4 □□

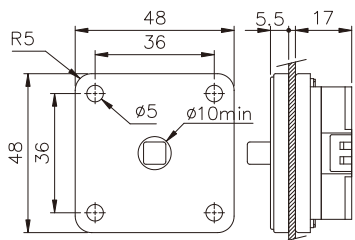

TCS5 □□

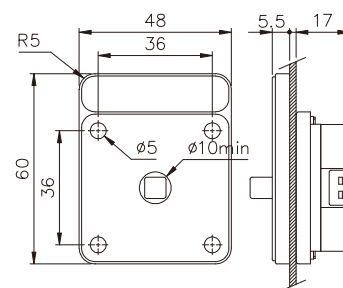

TCS6 □□

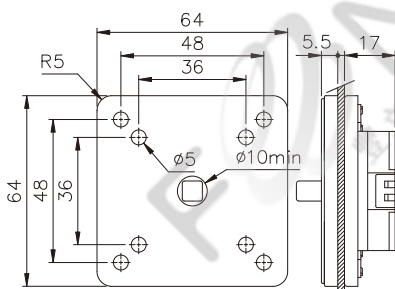

TCS7 □□

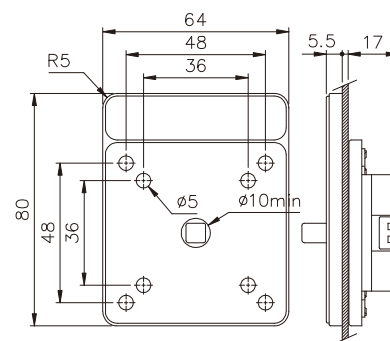

## ■長銘板型號說明

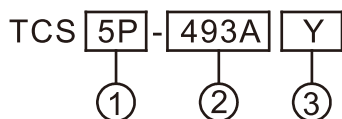

項次	代號	說明
1. 長銘板尺寸	5P	48*60面板用
	7P	64*80面板用
2. 長銘板編號	240Z 497C	見本頁
3. 銘板顏色	空白	銀底黑字
	Y	黃底黑字

## ●長銘板編號

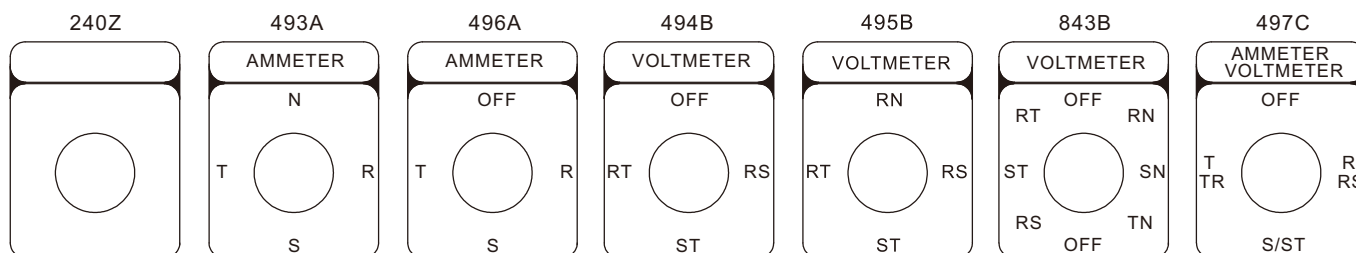

■ 銘板型號說明 TCS 4P - 242 Y

1   
 2   
 3

● 編號說明: 2 4 2

1   
 2   
 3

項次	代號	說明
1. 銘板尺寸	4P 6P	48*48 64*64
2. 銘板編號	240 842	見右側編號說明
3. 銘板顏色	空白 Y	銀底黑字 黃底黑字

項次	代號	說明
1. 段數	2~8	2~8段
2. 度數	4	45°
	9	90°
3. 序號	0~9	見本頁

● 銘板編號

The grid contains 80 circular switch plate templates, each with a unique number and various labels. The numbers range from 240 to 843. Labels include positions (1-8), directions (OFF, ON, FWD, REV, HIGH, LOW, STOP), and functions (MANU, AUTO, S, T, R, N, S, ST, TN).

## 組立說明

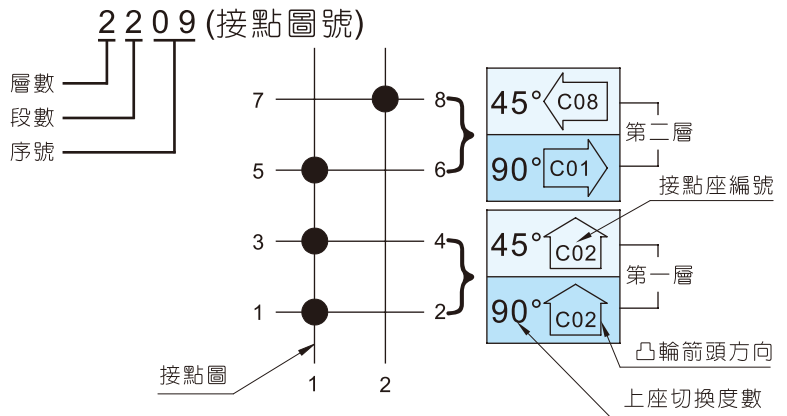
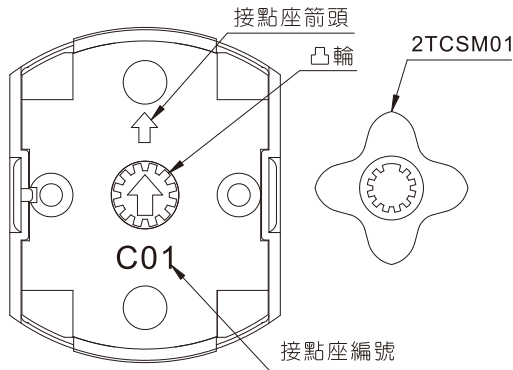

- 將2TCSM01套上凸輪,以接點座箭頭朝上為基準,旋轉凸輪使凸輪上的箭頭指向所需的方向。
- 客戶可依需求訂購雙點接點座,編號為TCS□-C01~CA1,或單點接點座,編號為TCS□-S01~SA1。

- 組立方式:以上圖為例  
當上座切換度數為45°時,第一層接點座編號為C02箭頭轉為朝上,第二層接點座編號為C08箭頭轉為朝左。
- 當上座切換度數為90°時,第一層接點座編號為C02箭頭轉為朝上,第二層接點座編號為C01箭頭轉為朝右。

## 接點圖

一層

1201(0 2A) 	1202 	1203 	1204 
1205(1A*2) 	1206 	1207 	1208 
1209 	1219 	1220 	1301(1A 0 1A) 
1302 	1303 	1304 	1305 
1306 	1307 	1308 	1309 
1310 	1311 	1312 	1313 



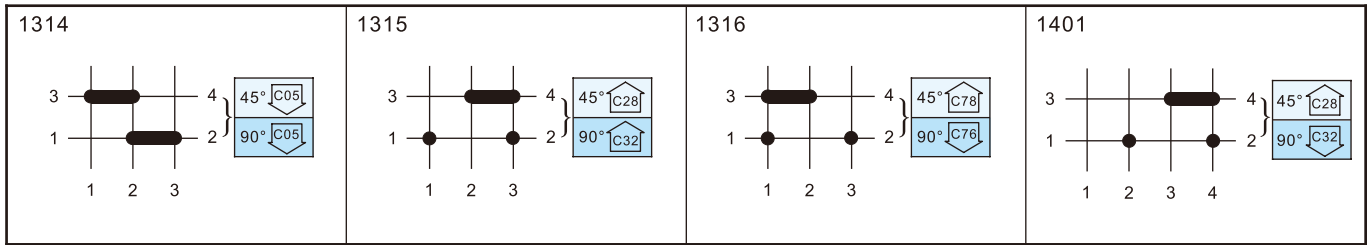

二層

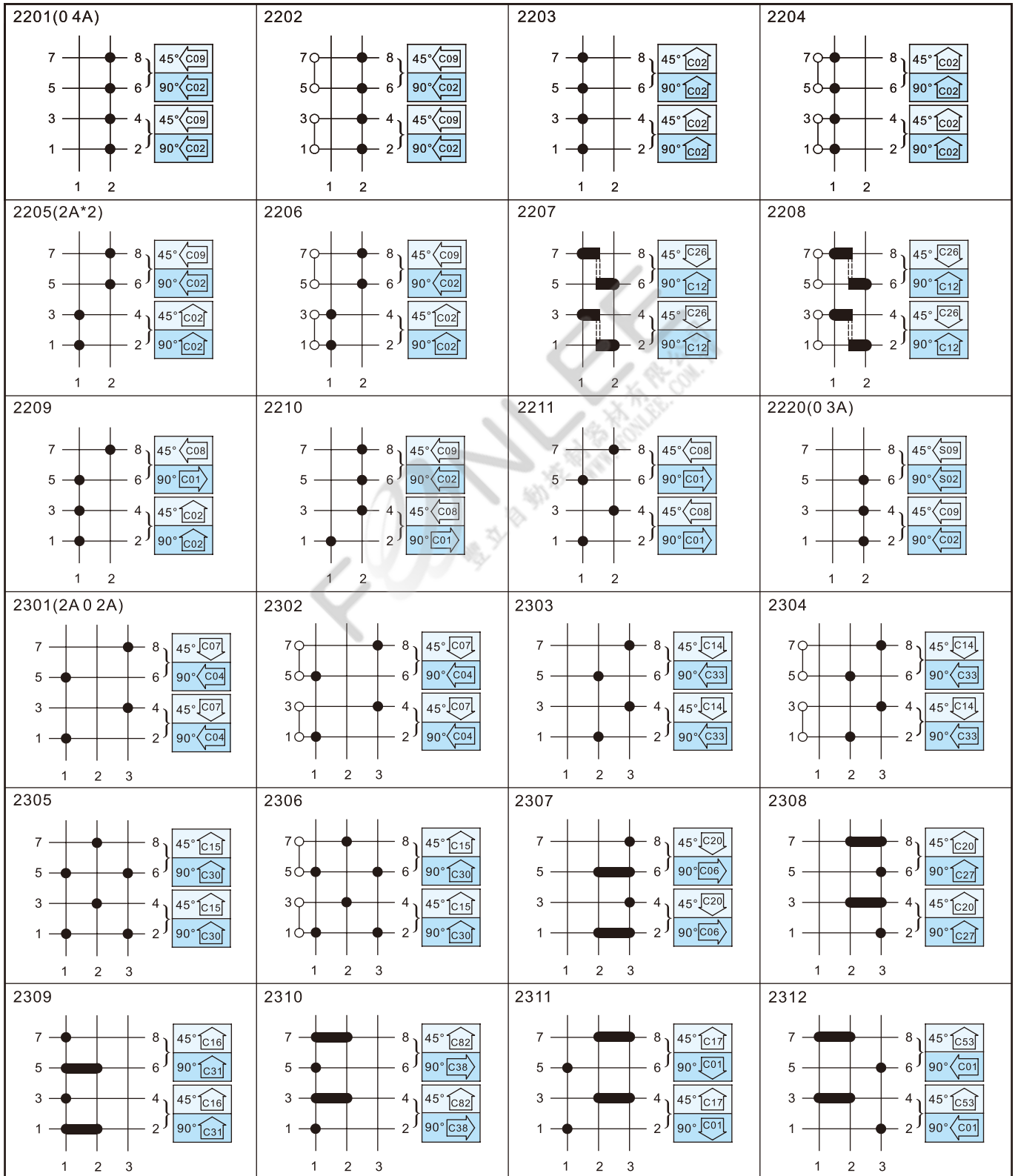

<p>2313</p>	<p>2314</p>	<p>2315(1A*3)</p>	<p>2316</p>
<p>2317</p>	<p>2318</p>	<p>2319</p>	<p>2320</p>
<p>2321(3ØF.O.R 2P)</p>	<p>2322</p>	<p>2323</p>	<p>2324</p>
<p>2325</p>	<p>2326</p>	<p>2327</p>	<p>2328</p>
<p>2401(1A*4)</p>	<p>2402</p>	<p>2403</p>	<p>2404</p>
<p>2405</p>	<p>2406</p>	<p>2407</p>	<p>2408</p>
<p>2409</p>	<p>2410</p>	<p>2411</p>	<p>2412</p>

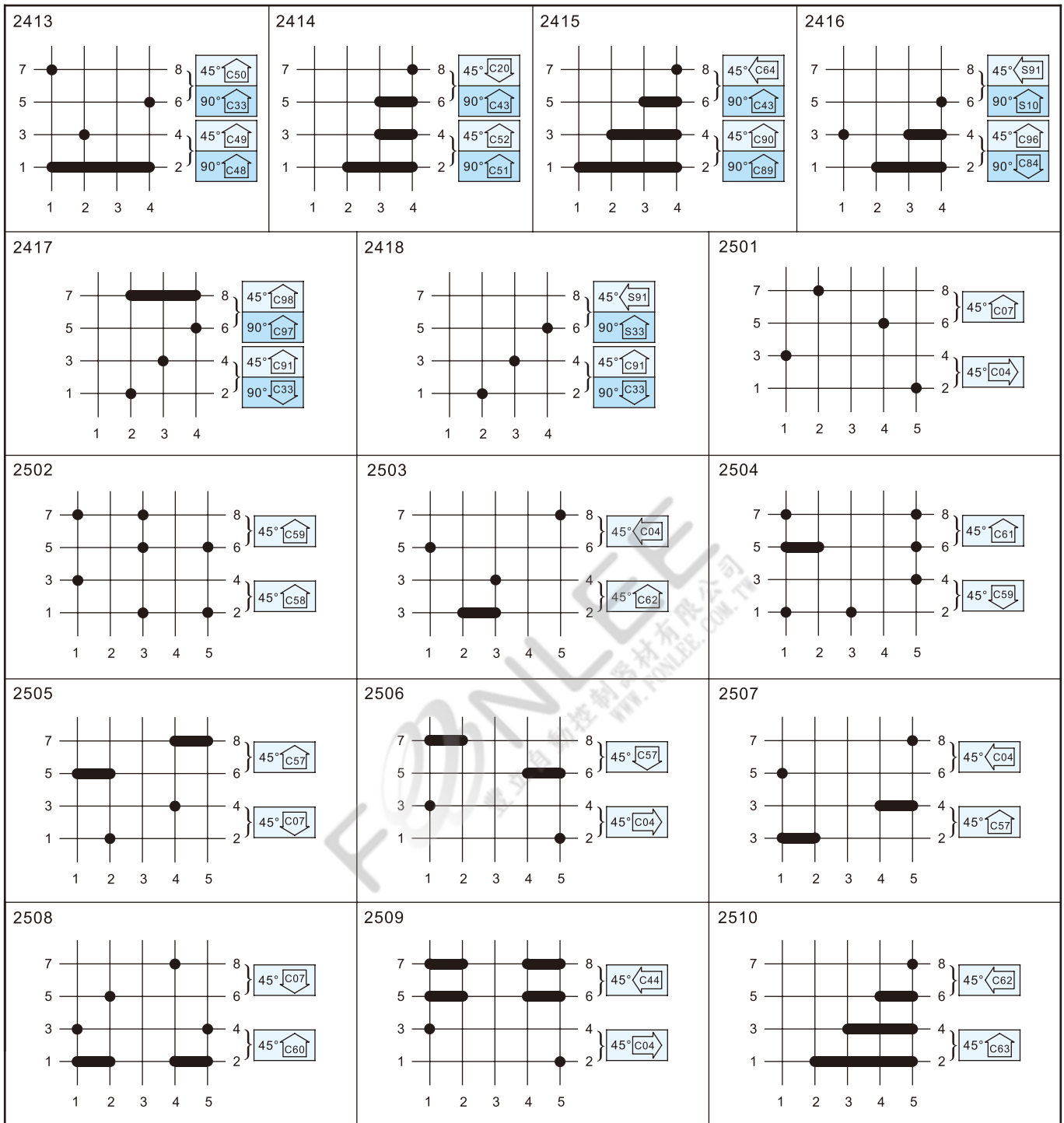

三層

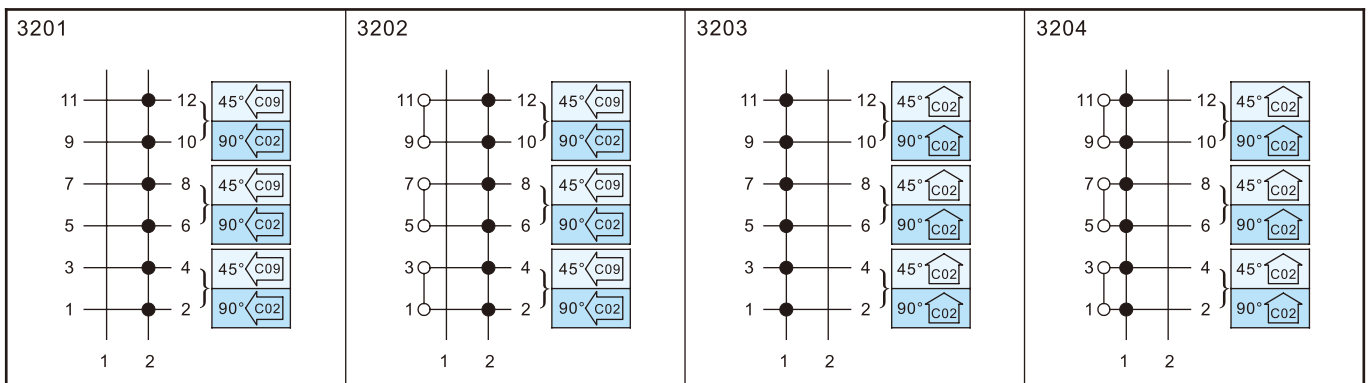

<p>3205(3A*2)</p>	<p>3206</p>	<p>3207</p>	<p>3208</p>
<p>3209</p>	<p>3210</p>	<p>3301(3A 0 3A)</p>	<p>3302</p>
<p>3303</p>	<p>3304</p>	<p>3305</p>	<p>3306</p>
<p>3307</p>	<p>3308</p>	<p>3309</p>	<p>3310</p>
<p>3311(2A*3)</p>	<p>3312</p>	<p>3313</p>	<p>3314</p>

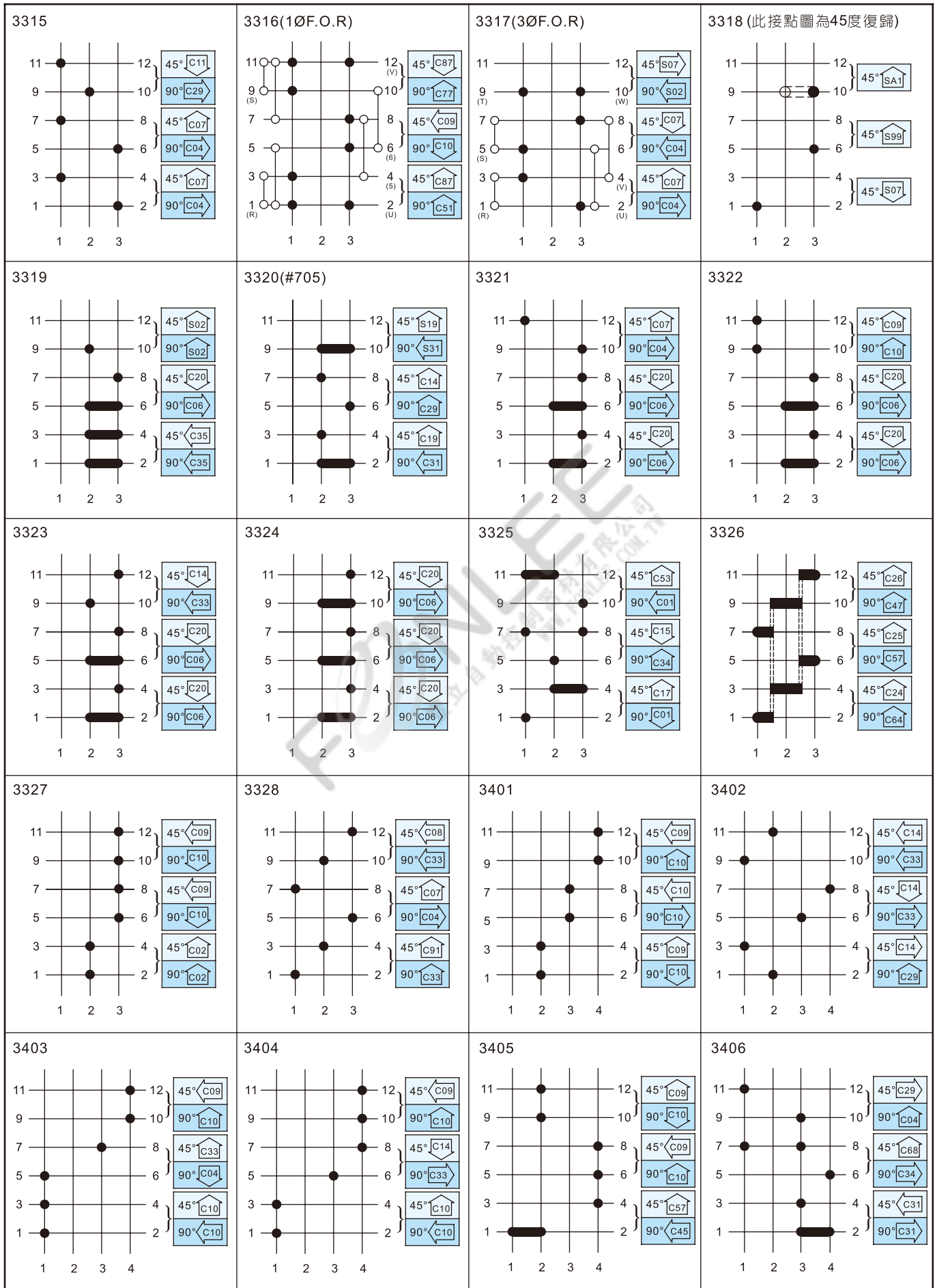

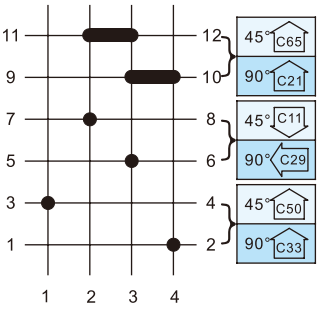
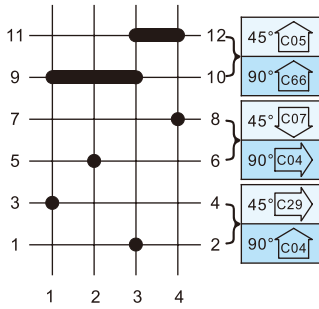
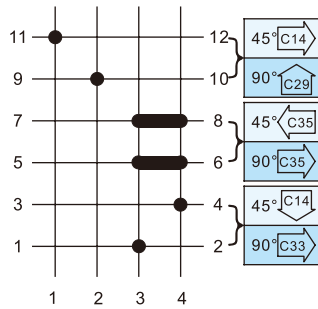
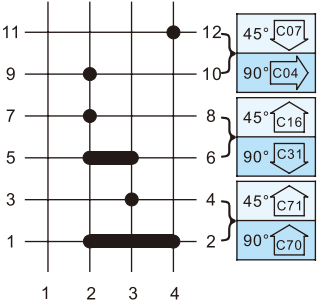
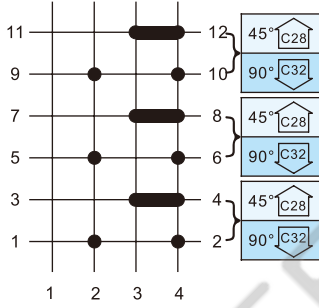
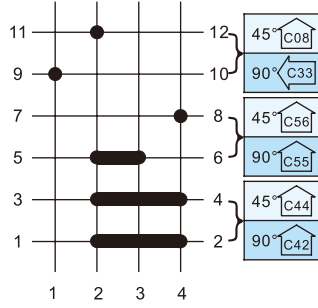
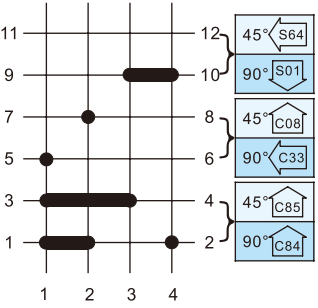
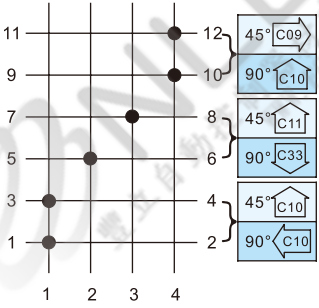
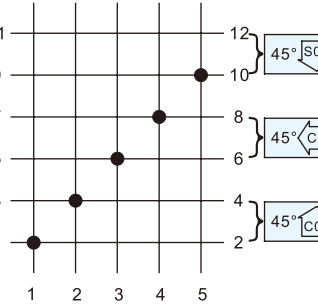
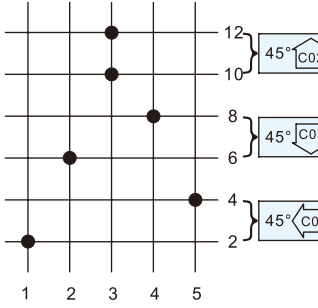
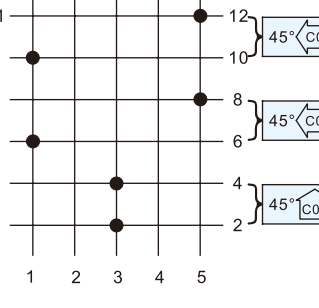
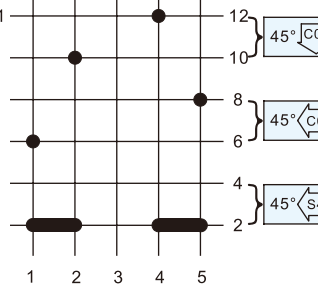
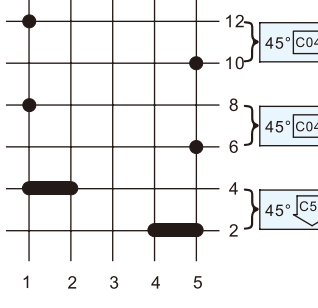
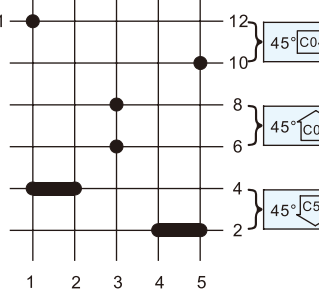
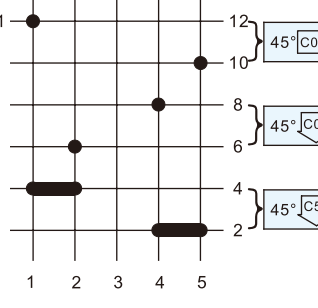

<p>3407</p> 	<p>3408</p> 	<p>3409</p> 
<p>3410</p> 	<p>3411</p> 	<p>3412</p> 
<p>3413</p> 	<p>3414</p> 	<p>3501(1A*5)</p> 
<p>3502</p> 	<p>3503</p> 	<p>3504</p> 
<p>3505</p> 	<p>3506</p> 	<p>3507</p> 

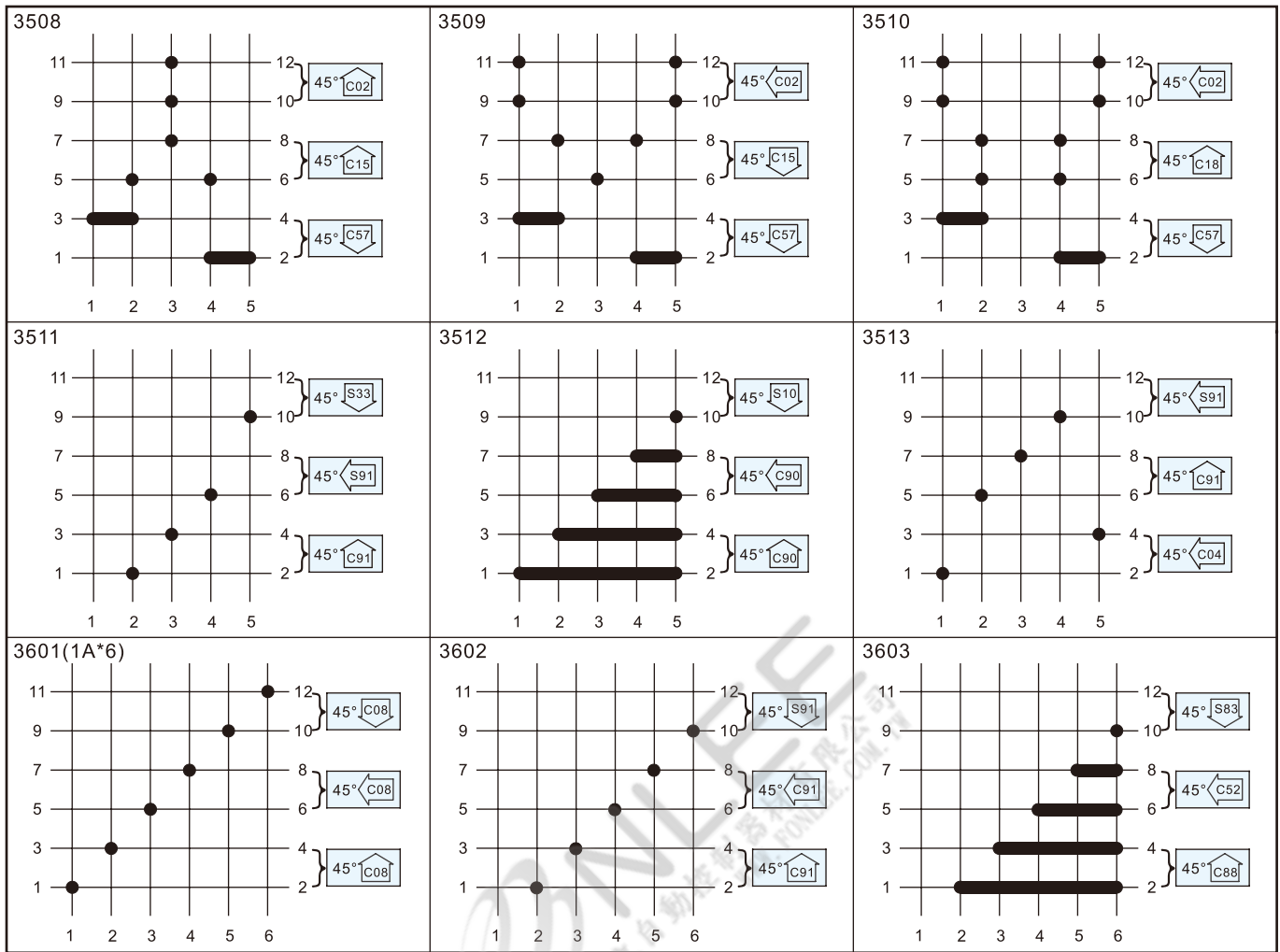

## 四層

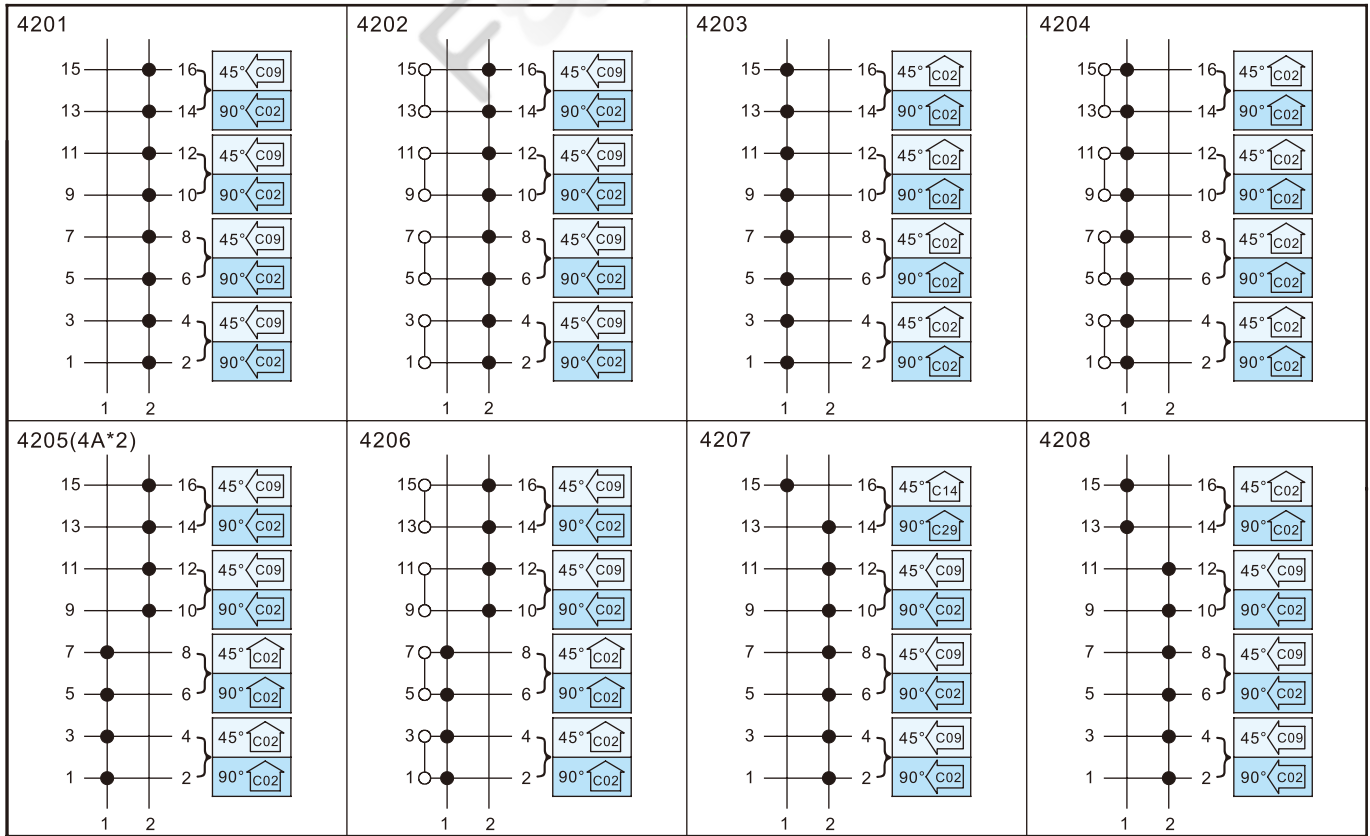

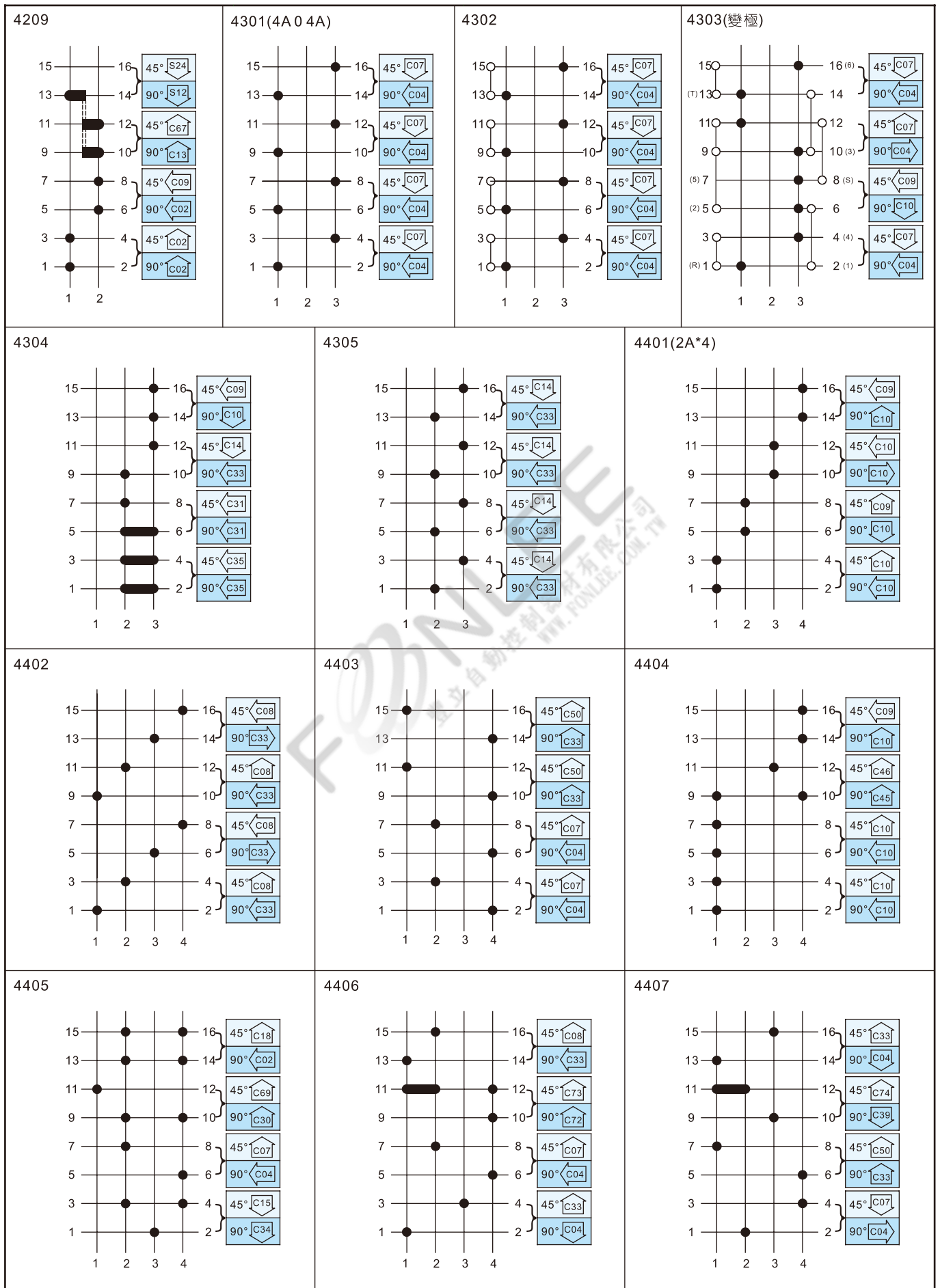

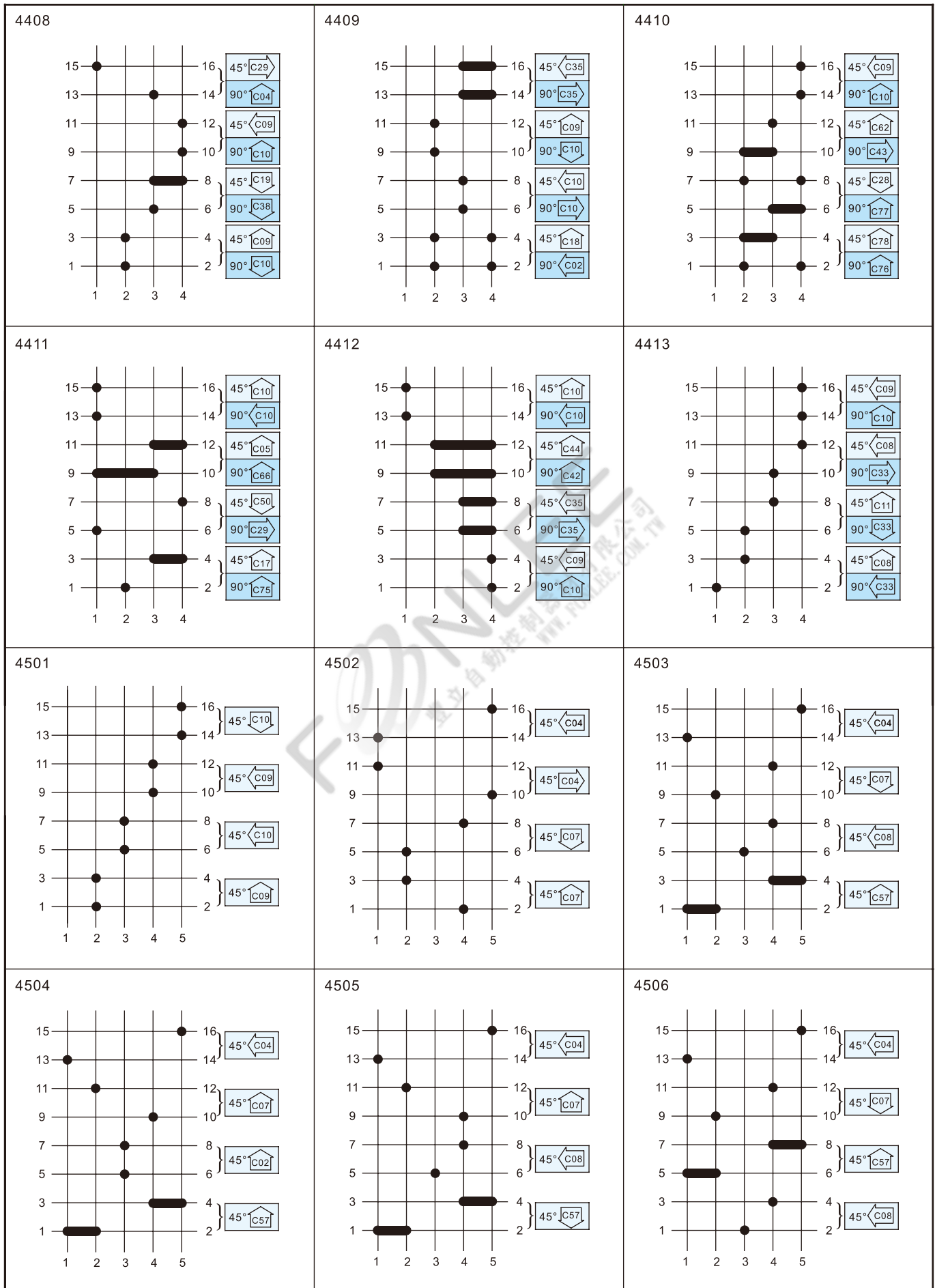

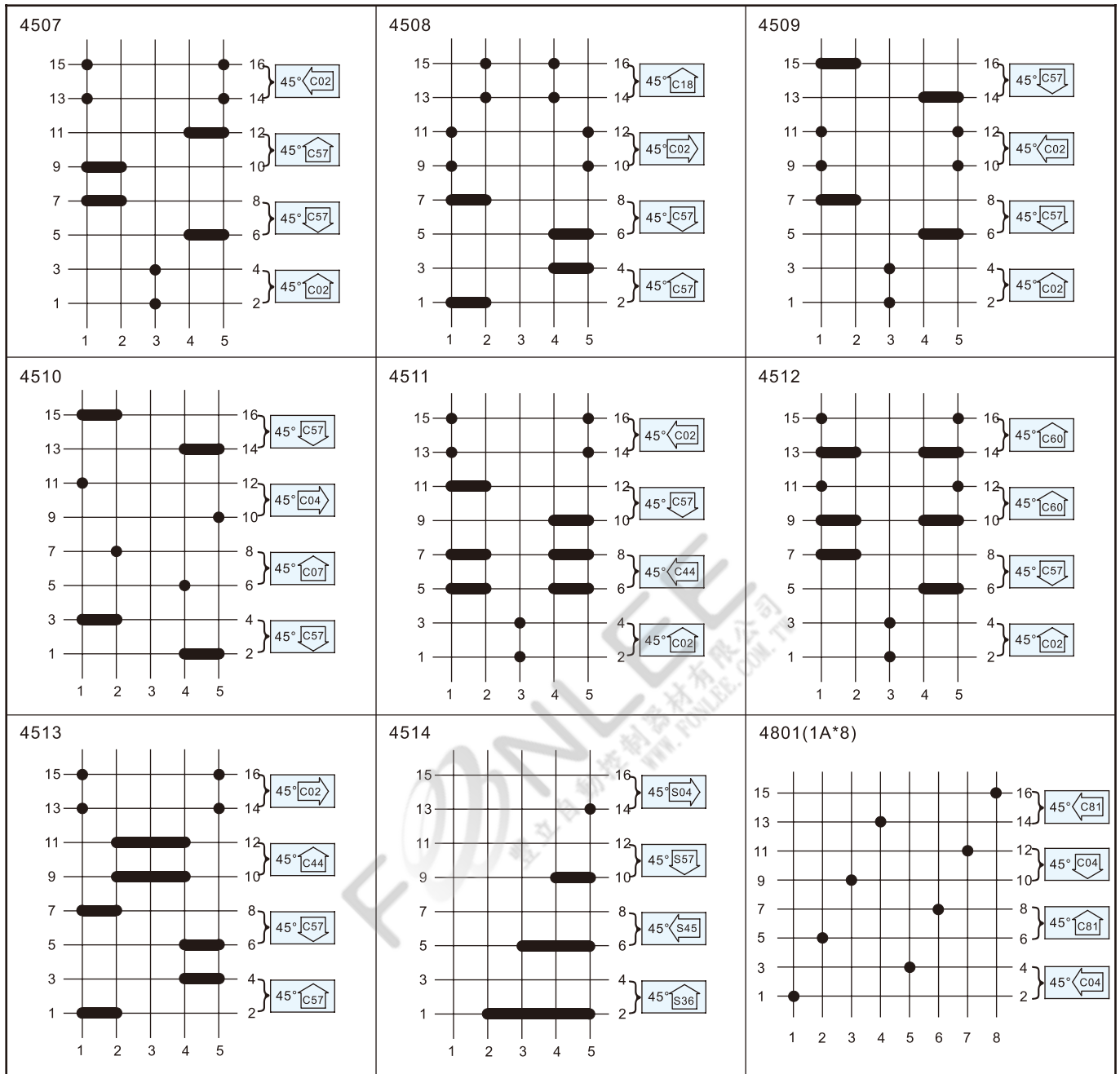

五層

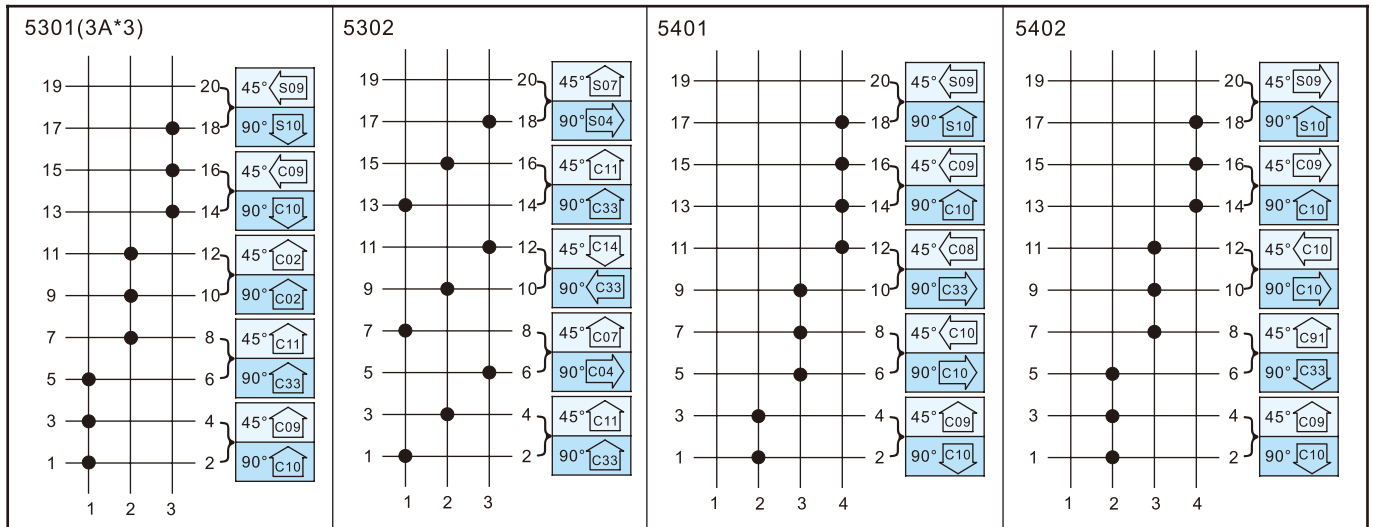



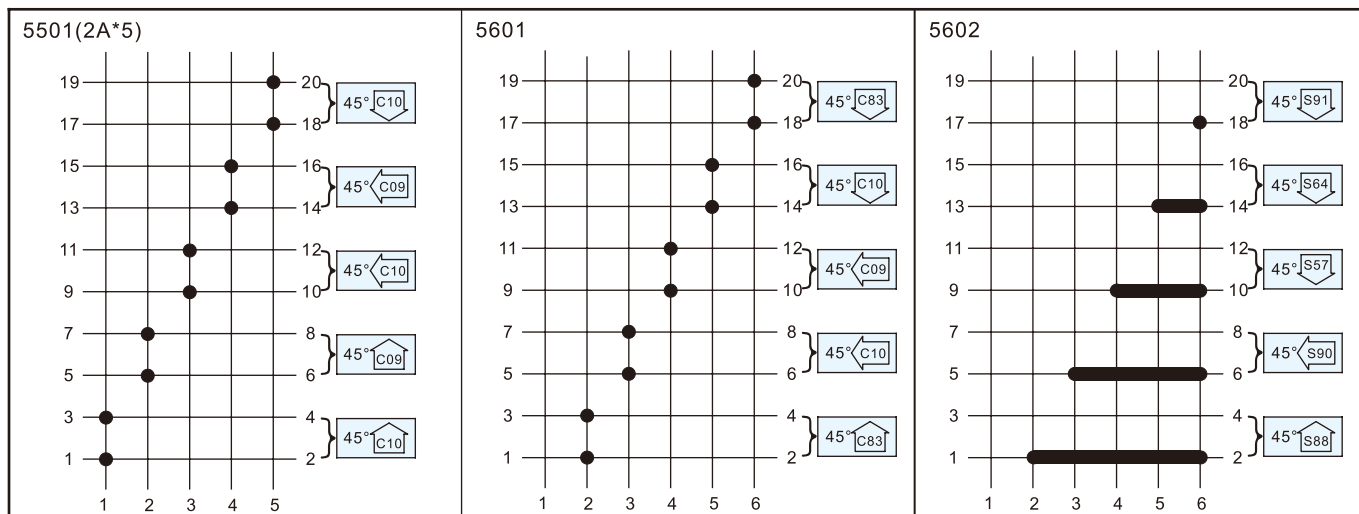

## 六層

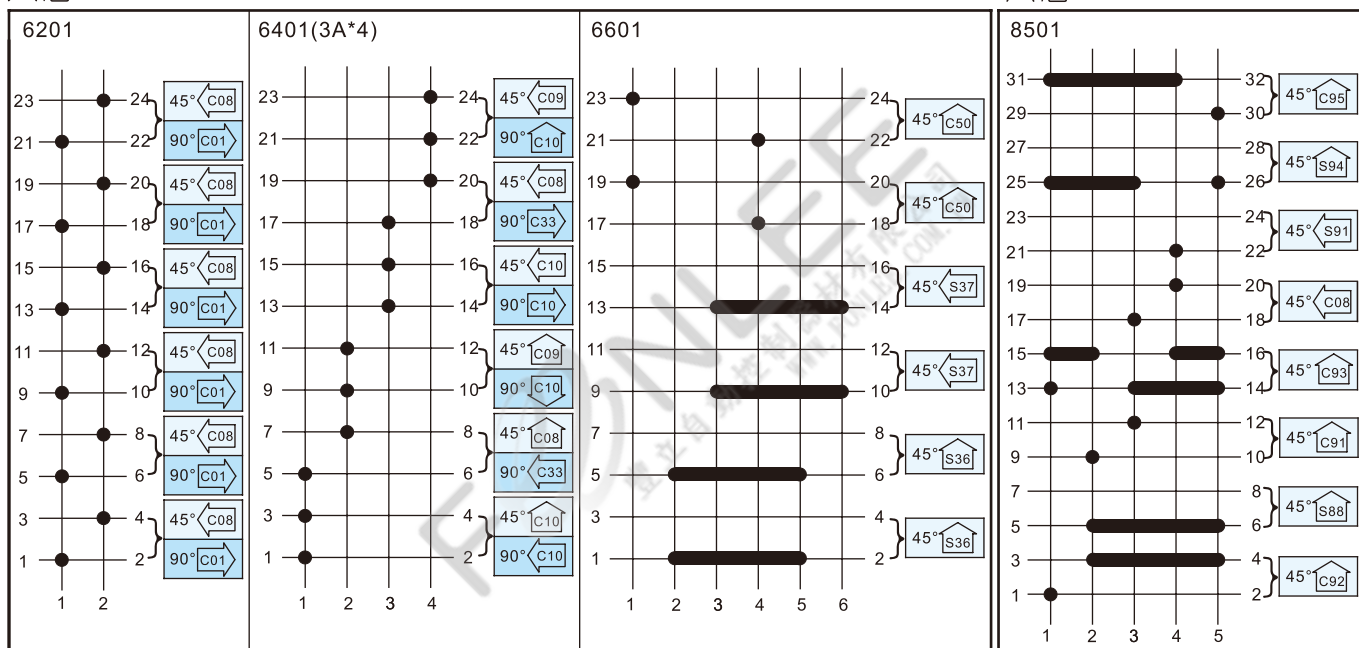

## 八層

### ■ 特殊接點訂購格式

● 客戶如有特殊接點需求，請影印下方空白接點圖後再畫上所需的接點方式。

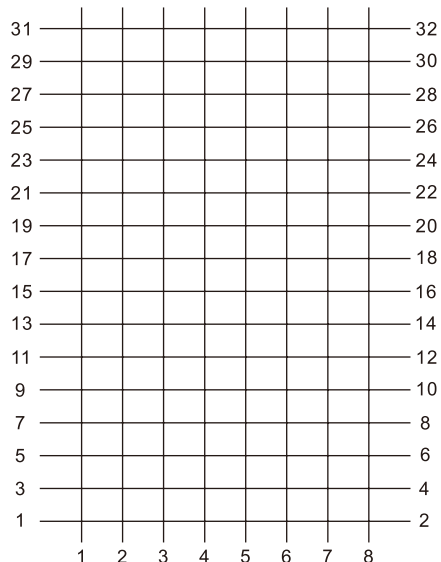

外形	<input type="checkbox"/> 2 (Ø22/Ø25mm)
	<input type="checkbox"/> 3 (Ø30mm)
把手	<input type="checkbox"/> 4 (48*48mm)
	<input type="checkbox"/> 5 (48*60mm)
	<input type="checkbox"/> 6 (64*64mm)
	<input type="checkbox"/> 7 (64*80mm)
	<input type="checkbox"/> S (短把手)
段數	<input type="checkbox"/> L (長把手)
	<input type="checkbox"/> O (八角把手)
	<input type="checkbox"/> K (鑰匙)
	<input type="checkbox"/> 段(2~8段)
度數	<input type="checkbox"/> 4 (45度)
	<input type="checkbox"/> 9 (90度)

銘板 編號	<input type="text"/>	(見 TA23頁)
長銘板 編號	<input type="text"/>	(見 TA22頁)
容量	<input type="checkbox"/> 1 (10安培)	
	<input type="checkbox"/> 2 (16安培)	
	<input type="checkbox"/> 3 (25安培)	
復歸	<input type="checkbox"/> 是	
	<input type="checkbox"/> 否	
接點 方式		
數量	<input type="text"/>	PCS.

## ■ 特性

- Ø22/Ø25/Ø30系列上下座以獨家專利的按鈕式組裝及拆卸，由上座、固定座與接點座三部份組成，為三段可拆組式。
- 獨創接點座模組化，拆換接點座時內部零件不致分解四散。
- 接點座可以自行組裝及拆卸，可降低客戶因機種過多的庫存。
- 接點座可依需要加裝，方便的卡式固定，不需拆鎖螺絲。
- 接線螺絲由一般的側鎖式改為後鎖式，方便客戶配線。
- 將接線端子及螺絲設計在接點座內部，可保護使用者不致誤觸電源。
- 所有端子的連接片皆以護蓋保護，避免誤觸電源。
- 容量以接點座顏色區分，10A為藍色，16A為灰色，25A為黑色。



## ■ 規格

電壓	容量		AC-3(kw)		AC-23A(kw)		AC-21A Iu=Ith	額定電壓	AC-3(HP)		馬達負載
	3 ph.	1 ph.	3 ph.	1 ph.	3 ph.	1 ph.			3 ph.	1 ph.	
220V~240V	1.5	0.55	1.8	0.75	10A	120V	0.75	0.33	10A		
380V~440V	2.2	0.75	3	1.1							
660V~690V	2.2	0.75	3	1.1							
220V~240V	3	1.5	4	2.2	16A	120V	1.5	0.5	16A		
380V~440V	5.5	2.2	7	3							
660V~690V	5.5	2.2	7	3							
220V~240V	4	3	5.5	3	25A	120V	3	1.5	25A		
380V~440V	7.5	3.7	11	5.5							
660V~690V	7.5	3.7	11	5.5							

IEC 60947-3, EN 60947-3

VDE 0660 part 107

HD A300

UL 77B7

## ■ 組立圖

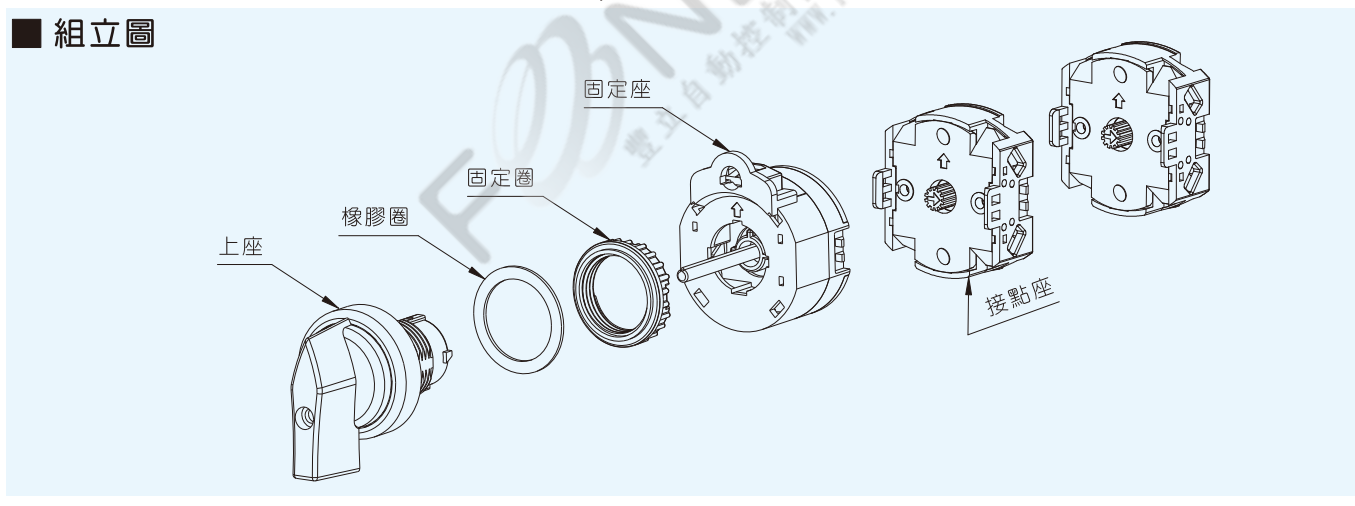

## ■ 上部之裝配

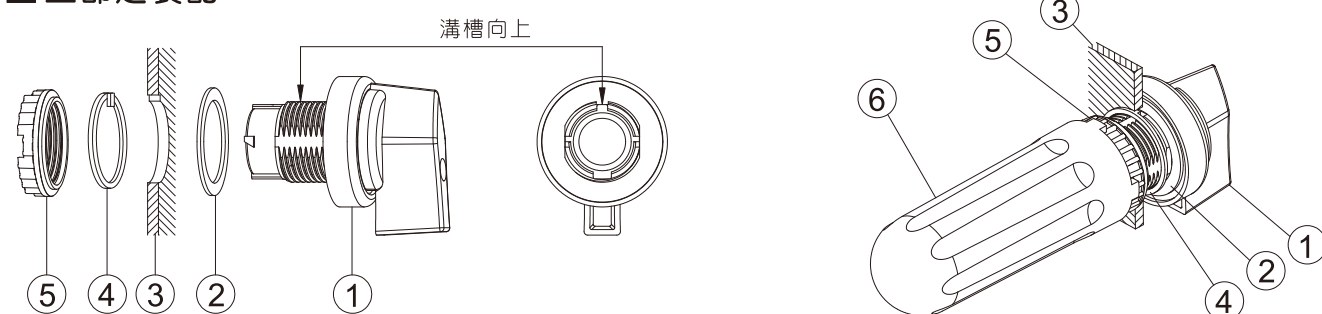

①	②	③	④	⑤	⑥
上座	橡膠圈	面板	止動環	固定圈	固定器

- 上座與橡膠圈置於面板上，插入孔徑內，止動環置於面板下對準上座與面板之溝槽，再將固定圈鎖緊即可。

## ■ 裝配孔徑

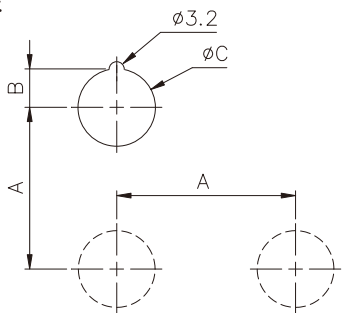

尺寸說明: 所有尺寸均為mm

項次	Ø22	Ø25	Ø30
A	60 min		
B	11.2	12.7	15.2
C	22.4	25.4	30.4

■ Ø22mm/Ø25mm系列尺寸與構造完全相同，由一共用之固定圈固定。

● Ø22/Ø25系列裝配方法

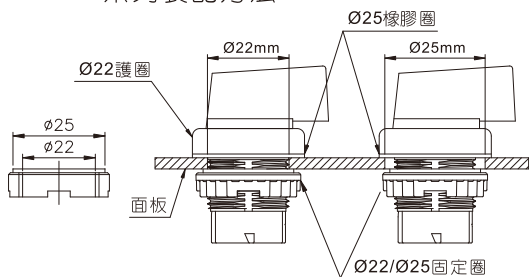

● Ø30系列裝配方法

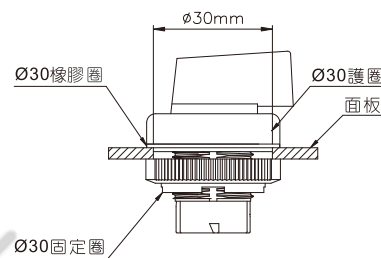

## ■ 組裝方式

● 上座與固定座之裝卸 (如圖一)

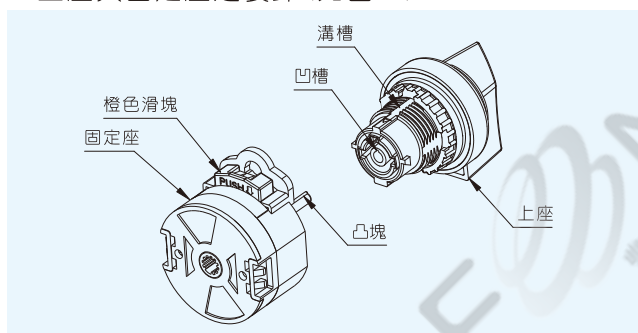

(圖一)

裝配: 先將固定座之凸塊對準上座凹槽插入後旋轉固定座使固定座橙色滑塊PUSH↓對準上座溝槽壓入, 即可固定。

拆卸: 以手或一字起子 (螺絲刀), 插入橙色滑塊上端之圓內, 下壓橙色滑塊即可拆卸。

● 固定座與接點座之裝卸 (如圖二)

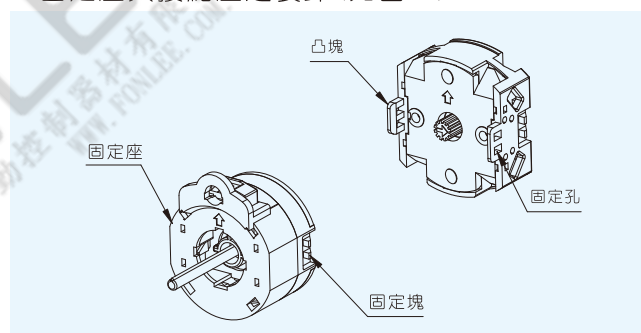

(圖二)

裝配: 固定座上凸起之固定塊對準接點座之固定孔推入, 即可固定。

拆卸: 以一字起子 (螺絲刀), 分別插入接點座之凸塊往上撬起, 即可拆卸。

## ■ 附 件 (連接片)

<p>TCS-2H</p>	<p>TCS-2L</p>	<p>TCS-2R</p>
<p>TCS-3L</p>	<p>TCS-3R</p>	<p>● TCS-3L/TCS-3R的中間端子可依需求折斷, 成為跨接端子。</p>

■ 客戶訂購成品，請參閱本頁之成品型號說明。

■ 成品型號說明 (2~3段選用)

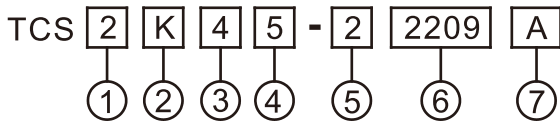

項次	代號	說明
1.固定孔徑	2	Ø22mm/Ø25mm
	3	Ø30mm
2.把手	S	選擇開關
	K	鑰匙開關
	Z	鑰匙開關 (鋅合金)
3.動作方式	1	 45°二段
	2	 90°二段
	3	 45°二段復歸
	4	 45°三段
	5	 90°三段
	6	 45°三段復歸

4.鑰匙抽出位置 (限鑰匙開關選用)	1		0,1皆可抽出		
	2		0可抽出		
	3		1可抽出		
	4	5		0,1,2皆可抽出	
				0可抽出	
	6	7		0,1,2皆可抽出	
				0可抽出	
5.容量	1	10A			
	2	16A			
	3	25A			
6.接線圖號	見 TA24~ TA35頁				
7.鑰匙編號	A	3313	E	3131	
	B	1313	F	3133	
	C	1331	G	3212	
	D	3113	H	3331	

■ 成品型號說明 (4~8段選用)

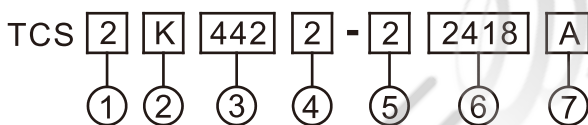

項次	代號	說明
1.固定孔徑	2	Ø22mm/Ø25mm
	3	Ø30mm
2.把手	S	選擇開關
	K	鑰匙開關

3.段數,度數 銘板編號	440 ~ 842	見 TA23頁		
4.鑰匙抽出位置 (限鑰匙開關選用)	1	皆可抽出		
	2	0可抽出		
5.容量	1	10A		
	2	16A		
	3	25A		
6.接線圖號	見 TA24~ TA35頁			
7.鑰匙編號	A	3313	E	3131
	B	1313	F	3133
	C	1331	G	3212
	D	3113	H	3331

■ 外觀尺寸

TCS2S□□-□□

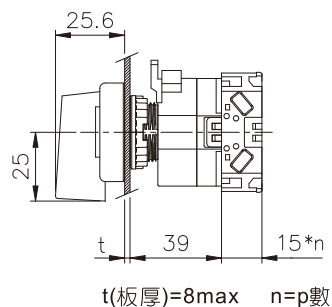

TCS2K□□-□□

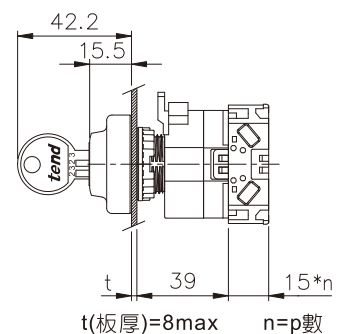

■ 訂購組件自行組裝，請參閱右側組裝示意圖及本頁上的組件型號說明。

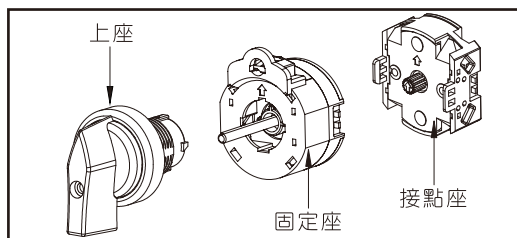

## ■ 上座型號說明

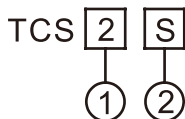

項次	代號	說明
1. 固定孔徑	2	Ø22/Ø25
	3	Ø30

2. 把手	S	短把手
	K	鑰匙
	Z	鑰匙(鋅合金)

## ■ 外觀尺寸

### TCS2S、TCS3S

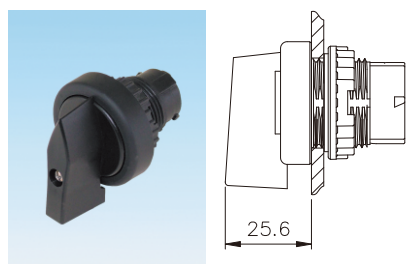

### TCS2K、TCS3K

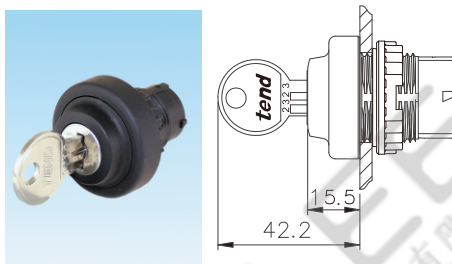

### TCS2Z、TCS3Z

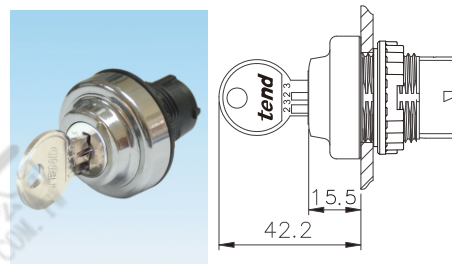

## ■ 固定座型號說明

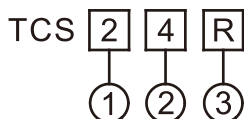

項次	代號	說明
1. 段數	2~8	2~8段
2. 度數	4	45°
	9	90°
3. 動作特性 (限45°2段、3段用)	空白	保持
	R	復歸(90°無復歸)

## ■ 外觀尺寸

TCS □ □ □

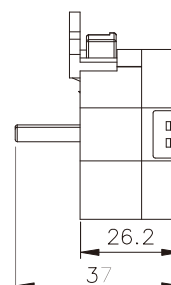
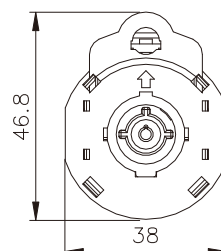

● 22mm、25mm、30mm固定座為共用。

## ■ 接點座型號說明

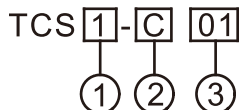

項次	代號	說明
1. 容量	1	10A
	2	16A
	3	25A
2. 接點數量	S	單接點
	C	雙接點
3. 接點座編號	C01 CA1	見 TA22~ TA33頁

## ■ 外觀尺寸

TCS □ -C01~CA1

TCS □ -S01~SA1

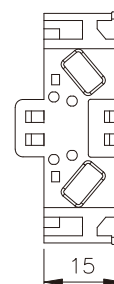
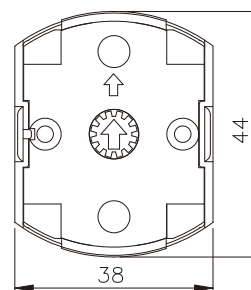
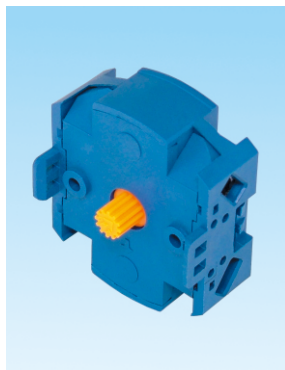



## ■ Ø22/Ø25/Ø30系列壓克力銘牌(P)及鋁銘牌(M)

TN22P- (22塑膠銘牌)	TN22M- (22鋁銘牌)
TN25P- (25塑膠銘牌)	TN25M- (25鋁銘牌)
TN30P- (30塑膠銘牌)	TN30M- (30鋁銘牌)

	A	B	C	D
TN22P	Ø22.3	41	32	52.5
TN22M	Ø22.2	31	26.7	42
TN25P	Ø25.5	41	32	52.5
TN25M	Ø24.8	31	26.7	42
TN30P	Ø30.5	41	32	52.5
TN30M	Ø30.2	38.3	32.7	51.9

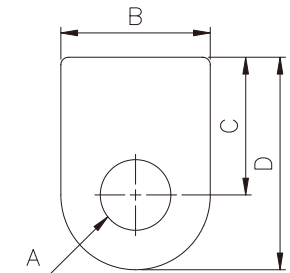

13	14	15	16	17	18	19	20
OFF ON	ON ON	ON OFF ON	FWD REV	FWD OFF REV	AUTO MANU	AUTO OFF MANU	STOP START

21	22	00
MANU OFF AUTO	1 0 2	

40	41	42	43	60	61	62	63	71
手動 自動	手動 停止 自動	逆轉 正轉	逆轉 停止 正轉	手動 自動	手動 停止 自動	逆轉 正轉	逆轉 停止 正轉	○ I

72	73	74
I II	I ○ II	I II III

## tend 拉出式多段開關

### ■ 特性

- 使用時需要將把手拉出後才可切換，視窗在ON的位置為紅色、在OFF的位置為綠色。
- 本開關皆為45度雙復歸，裝配孔距為48mm\*48mm。
- 容量以接點座顏色區分，10A為藍色，16A為灰色，25A為黑色。

### ■ 型號說明

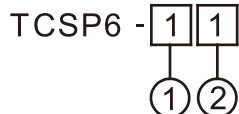

項次	代號	說明
1. 容量	1	10A
	2	16A
	3	25A
2. 接點圖號	1	1a 0 1a
	2	1a 0 1a 附殘留

### ■ 外觀尺寸、面板及接點圖

