



**16A**

POLES 極數	VOLTAGE 電 壓	POS(E) E 極	REF. 型 號	DIMENSIONS 尺 寸			
				a	b	k	sw
	V	h					
2P+E	110	4	CP20301614	132	76	6-15	41
3P+E		4	CP20401614	138	81	6-15	41
3P+E+N		4	CP20501614	140	90	8-16	45
2P+E	220	6	CP20301624	132	76	6-15	41
3P+E		9	CP20401624	138	81	6-15	41
3P+E+N		9	CP20501624	140	91	8-16	45
2P+E	400	9	CP20301644	132	76	6-15	41
3P+E		6	CP20401644	138	81	6-15	41
3P+E+N		6	CP20501644	140	91	8-16	45
2P+E	500	7	CP20301654	132	76	6-15	41
3P+E		7	CP20401654	138	81	6-15	41
3P+E+N		7	CP20501654	140	91	8-16	45

**32A**

2P+E	110	4	CP20303214	160	94	10-20	54
3P+E		4	CP20403214	160	94	10-20	54
3P+E+N		4	CP20503214	168	98	12-22	54
2P+E	220	6	CP20303224	160	94	10-20	54
3P+E		9	CP20403224	160	94	10-20	54
3P+E+N		9	CP20503224	168	98	12-22	54
2P+E	400	9	CP20303244	160	94	10-20	54
3P+E		6	CP20403244	160	94	10-20	54
3P+E+N		6	CP20503244	168	98	12-22	54
2P+E	500	7	CP20303254	160	94	10-20	54
3P+E		7	CP20403254	160	94	10-20	54
3P+E+N		7	CP20503254	168	98	12-22	54

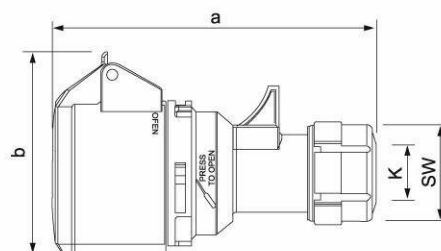



**63A**

POLES 極數	VOLTAGE 電 壓	POS(E) E 極	REF. 型 號	DIMENSIONS		
				尺	寸	
	V	h		a	b	PG
2P+E	110	4	CP11306317	230	109	36
2P+E		6	CP11306327	230	109	36
3P+E	220	9	CP11406327	230	109	36
3P+E+N		9	CP11506327	230	109	36
2P+E	400	9	CP11306347	230	109	36
3P+E		6	CP11406347	230	109	36
3P+E+N		6	CP11506347	230	109	36
2P+E	500	7	CP11306357	230	109	36
3P+E		7	CP11406357	230	109	36
3P+E+N		7	CP11506357	230	109	36

**125A**

2P+E	110	4	CP11312517	295	124
2P+E		6	CP11312527	295	124
3P+E	220	9	CP11412527	295	124
3P+E+N		9	CP11512527	295	124
2P+E	400	9	CP11312547	295	124
3P+E		6	CP11412547	295	124
3P+E+N		6	CP11512547	295	124
2P+E	500	7	CP11312557	295	124
3P+E		7	CP11412557	295	124
3P+E+N		7	CP11512557	295	124

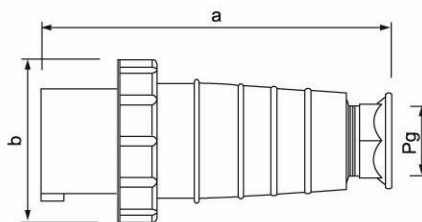





**16A**

POLES 極數	VOLTAGE 電壓	POS(E) E極	REF. 型號	DIMENSIONS 尺寸				
	V	h		a	b	c	K	SW
2P+E	110	4	CP11301614	120	82	47	6-15	41
3P+E		4	CP11401614	129	88	52	6-15	41
3P+E+N		4	CP11501614	132	95	61	8-16	45
2P+E	220	6	CP11301624	120	82	47	6-15	41
3P+E		9	CP11401624	129	88	52	6-15	41
3P+E+N		9	CP11501624	132	95	61	8-16	45
2P+E	400	9	CP11301644	120	82	47	6-15	41
3P+E		6	CP11401644	129	88	52	6-15	41
3P+E+N		6	CP11501644	132	95	61	8-16	45
2P+E	500	7	CP11301654	120	82	47	6-15	41
3P+E		7	CP11401654	129	88	52	6-15	41
3P+E+N		7	CP11501654	132	95	61	8-16	45

**32A**

2P+E	110	4	CP11303214	150	100	63	10-22	54
3P+E		4	CP11403214	148	100	63	10-22	54
3P+E+N		4	CP11503214	157	109	70	10-22	54
2P+E	220	6	CP11303224	150	100	63	10-22	54
3P+E		9	CP11403224	148	100	63	10-22	54
3P+E+N		9	CP11503224	157	109	70	10-22	54
2P+E	400	9	CP11303244	150	100	63	10-22	54
3P+E		6	CP11403244	148	100	63	10-22	54
3P+E+N		6	CP11503244	157	109	70	10-22	54
2P+E	500	7	CP11303254	150	100	63	10-22	54
3P+E		7	CP11403254	148	100	63	10-22	54
3P+E+N		7	CP11503254	157	109	70	10-22	54

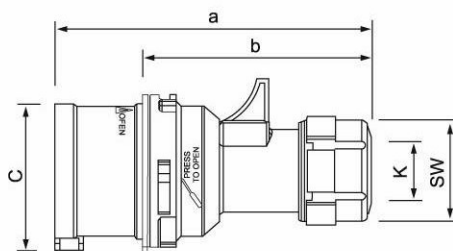



**16A**

POLES 極數	VOLTAGE 電壓	POS(E) E極	REF. 型號	DIMENSIONS 尺寸							
				a	b	c	d	e	f	g	h
2P+E	110	4	CP00301614	65	85	52	60	33	50	56	62
3P+E		4	CP00401614	65	85	52	60	33	50	62	69
3P+E+N		4	CP00501614	90	100	77	85	36	49	70	77
2P+E	220	6	CP00301624	65	85	52	60	33	50	56	62
3P+E		9	CP00401624	65	85	52	60	33	50	62	69
3P+E+N		9	CP00501624	90	100	77	85	36	49	70	77
2P+E	400	9	CP00301644	65	85	52	60	33	50	56	62
3P+E		6	CP00401644	65	85	52	60	33	50	62	69
3P+E+N		6	CP00501644	90	100	77	85	36	49	70	77
2P+E	500	7	CP00301654	65	85	52	60	33	50	56	62
3P+E		7	CP00401654	65	85	52	60	33	50	62	69
3P+E+N		7	CP00501654	90	100	77	85	36	49	70	77

**32A**

2P+E	110	4	CP00303214	90	100	77	85	42	60	71	78
3P+E		4	CP00403214	90	100	77	85	42	60	71	78
3P+E+N		4	CP00503214	90	100	77	85	42	60	78	87
2P+E	220	6	CP00303224	90	100	77	85	42	60	71	78
3P+E		9	CP00403224	90	100	77	85	42	60	71	78
3P+E+N		9	CP00503224	90	100	77	85	42	60	78	87
2P+E	400	9	CP00303244	90	100	77	85	42	60	71	78
3P+E		6	CP00403244	90	100	77	85	42	60	71	78
3P+E+N		6	CP00503244	90	100	77	85	42	60	78	87
2P+E	500	7	CP00303254	90	100	77	85	42	60	71	78
3P+E		7	CP00403254	90	100	77	85	42	60	71	78
3P+E+N		7	CP00503254	90	100	77	85	42	60	78	87

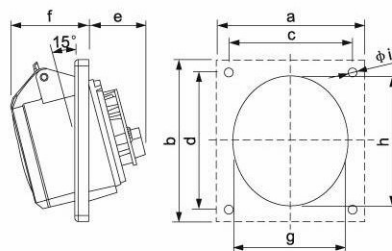





**16A**

POLES 極數	VOLTAGE 電 壓	POS(E) E 極	REF. 型 號	DIMENSIONS 尺 寸								
				a	b	c	d	e	f	g	h	
	V	h										
2P+E	110	4	CP40301614	76	76	60	60	16	59	5.5	47	
3P+E		4	CP40401614	76	76	60	60	16	59	5.5	54	
3P+E+N		4	CP40501614	76	76	60	60	16	59	5.5	60	
2P+E	220	6	CP40301624	76	76	60	60	16	59	5.5	47	
3P+E		9	CP40401624	76	76	60	60	16	59	5.5	54	
3P+E+N		9	CP40501624	76	76	60	60	16	59	5.5	60	
2P+E	400	9	CP40301644	76	76	60	60	16	59	5.5	47	
3P+E		6	CP40401644	76	76	60	60	16	59	5.5	54	
3P+E+N		6	CP40501644	76	76	60	60	16	59	5.5	60	
2P+E	500	7	CP40301654	76	76	60	60	16	59	5.5	47	
3P+E		7	CP40401654	76	76	60	60	16	59	5.5	54	
3P+E+N		7	CP40501654	76	76	60	60	16	59	5.5	60	

**32A**

2P+E	110	4	CP40303214	76	76	60	60	21	70	5.5	60
3P+E		4	CP40403214	76	76	60	60	21	70	5.5	60
3P+E+N		4	CP40503214	76	76	60	60	21	70	5.5	68
2P+E	220	6	CP40303224	76	76	60	60	21	70	5.5	60
3P+E		9	CP40403224	76	76	60	60	21	70	5.5	60
3P+E+N		9	CP40503224	76	76	60	60	21	70	5.5	68
2P+E	400	9	CP40303244	76	76	60	60	21	70	5.5	60
3P+E		6	CP40403244	76	76	60	60	21	70	5.5	60
3P+E+N		6	CP40503244	76	76	60	60	21	70	5.5	68
2P+E	500	7	CP40303254	76	76	60	60	21	70	5.5	60
3P+E		7	CP40403254	76	76	60	60	21	70	5.5	60
3P+E+N		7	CP40503254	76	76	60	60	21	70	5.5	68

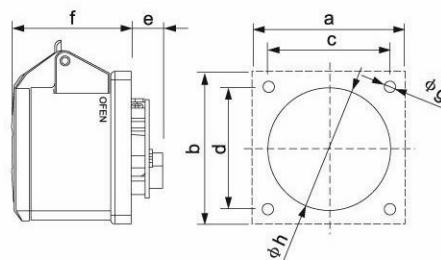



16A

POLES 極數	VOLTAGE 電 壓	POS(E) E 極	REF. 型 號	DIMENSIONS 尺 寸		
	V	h		a	b	MG
2P+E	110	4	CP30301614	154	82	25
3P+E		4	CP30401614	154	82	25
3P+E+N		4	CP30501614	152	82	25
2P+E	220	6	CP30301624	154	82	25
3P+E		9	CP30401624	154	82	25
3P+E+N		9	CP30501624	152	82	25
2P+E	400	9	CP30301644	154	82	25
3P+E		6	CP30401644	154	82	25
3P+E+N		6	CP30501644	152	82	25
2P+E	500	7	CP30301654	154	82	25
3P+E		7	CP30401654	154	82	25
3P+E+N		7	CP30501654	152	82	25

32A

2P+E	110	4	CP30303214	168	82	25
3P+E		4	CP30403214	168	82	25
3P+E+N		4	CP30503214	168	82	25
2P+E	220	6	CP30303224	168	82	25
3P+E		9	CP30403224	168	82	25
3P+E+N		9	CP30503224	168	82	25
2P+E	400	9	CP30303244	168	82	25
3P+E		6	CP30403244	168	82	25
3P+E+N		6	CP30503244	168	82	25
2P+E	500	7	CP30303254	168	105	25
3P+E		7	CP30403254	168	105	25
3P+E+N		7	CP30503254	168	105	25

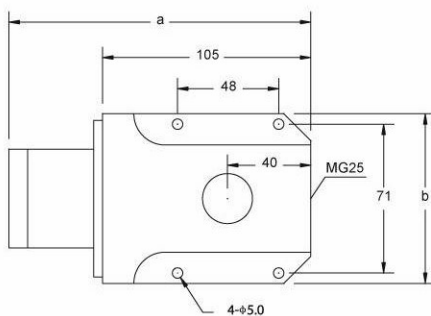





**63A**

POLES 極數	VOLTAGE 電壓	POS(E) E極	REF. 型號	DIMENSIONS 尺寸										
				a	b	c	d	e	f	g	h	i	j	k
2P+E	110	4	CP00306317	100	112	80	89	69	80	6.5	90	85	15	112
2P+E	220	6	CP00306327	100	112	80	89	69	80	6.5	90	85	15	112
3P+E		9	CP00406327	100	112	80	89	69	80	6.5	90	85	15	112
3P+E+N		9	CP00506327	100	112	80	89	69	80	6.5	90	85	15	112
2P+E	400	9	CP00306347	100	112	80	89	69	80	6.5	90	85	15	112
3P+E		6	CP00406347	100	112	80	89	69	80	6.5	90	85	15	112
3P+E+N		6	CP00506347	100	112	80	89	69	80	6.5	90	85	15	112
2P+E	500	7	CP00306357	100	112	80	89	69	80	6.5	90	85	15	112
3P+E		7	CP00406357	100	112	80	89	69	80	6.5	90	85	15	112
3P+E+N		7	CP00506357	100	112	80	89	69	80	6.5	90	85	15	112

**125A**

2P+E	110	4	CP00312517	120	130	100	108	97	80	7	105	95	15	124
2P+E	220	6	CP00312527	120	130	100	108	97	80	7	105	95	15	124
3P+E		9	CP00412527	120	130	100	108	97	80	7	105	95	15	124
3P+E+N		9	CP00512527	120	130	100	108	97	80	7	105	95	15	124
2P+E	400	9	CP00312547	120	130	100	108	97	80	7	105	95	15	124
3P+E		6	CP00412547	120	130	100	108	97	80	7	105	95	15	124
3P+E+N		6	CP00512547	120	130	100	108	97	80	7	105	95	15	124
2P+E	500	7	CP00312557	120	130	100	108	97	80	7	105	95	15	124
3P+E		7	CP00412557	120	130	100	108	97	80	7	105	95	15	124
3P+E+N		7	CP00512557	120	130	100	108	97	80	7	105	95	15	124

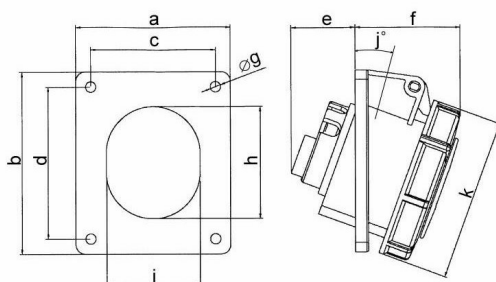



16A

POLES 極數	VOLTAGE 電 壓	POS(E) E 極	REF. 型 號	DIMENSIONS 尺 寸								
				a	b	c	d	e	f	g	h	PG
2P+E	110	4	CP00301617	65	85	52	60	32	45	56	61	5.5
3P+E		4	CP00401617	65	85	52	60	33	47	61	68.5	5.5
3P+E+N		4	CP00501617	90	100	77	85	36	54	70	77	5.5
2P+E	220	6	CP00301627	65	85	52	60	32	45	56	61	5.5
3P+E		9	CP00401627	65	85	52	60	33	47	61	68.5	5.5
3P+E+N		9	CP00501627	90	100	77	85	36	54	70	77	5.5
2P+E	400	9	CP00301647	65	85	52	60	32	45	56	61	5.5
3P+E		6	CP00401647	65	85	52	60	33	47	61	68.5	5.5
3P+E+N		6	CP00501647	90	100	77	85	36	54	70	77	5.5
2P+E	500	7	CP00301657	65	85	52	60	32	45	56	61	5.5
3P+E		7	CP00401657	65	85	52	60	33	47	61	68.5	5.5
3P+E+N		7	CP00501657	90	100	77	85	36	54	70	77	5.5

32A

2P+E	110	4	CP00303217	91	101	78	85	38	59	70	78	5.5
3P+E		4	CP00403217	91	101	78	85	38	59	70	78	5.5
3P+E+N		4	CP00503217	91	101	78	85	41	65	78	88	5.5
2P+E	220	6	CP00303227	91	101	78	85	38	59	70	78	5.5
3P+E		9	CP00403227	91	101	78	85	38	59	70	78	5.5
3P+E+N		9	CP00503227	91	101	78	85	41	65	78	88	5.5
2P+E	400	9	CP00303247	91	101	78	85	38	59	70	78	5.5
3P+E		6	CP00403247	91	101	78	85	38	59	70	78	5.5
3P+E+N		6	CP00503247	91	101	78	85	41	65	78	88	5.5
2P+E	500	7	CP00303257	91	101	78	85	38	59	70	78	5.5
3P+E		7	CP00403257	91	101	78	85	38	59	70	78	5.5
3P+E+N		7	CP00503257	91	101	78	85	41	65	78	88	5.5

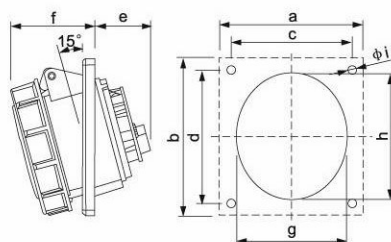





63A

POLES 極數	VOLTAGE 電 壓	POS(E) E 極	REF. 型 號	DIMENSIONS 尺 寸		
	V	h		a	b	PG
2P+E	110	4	CP20306317	245	114	36
2P+E	220	6	CP20306327	245	114	36
3P+E		9	CP20406327	245	114	36
3P+E+N		9	CP20506327	245	114	36
2P+E	400	9	CP20306347	245	114	36
3P+E		6	CP20406347	245	114	36
3P+E+N		6	CP20506347	245	114	36
2P+E	500	7	CP20306357	245	114	36
3P+E		7	CP20406357	245	114	36
3P+E+N		7	CP20506357	245	114	36

125A

2P+E	110	4	CP20312517	300	126
2P+E	220	6	CP20312527	300	126
3P+E		9	CP20412527	300	126
3P+E+N		9	CP20512527	300	126
2P+E	400	9	CP20312547	300	126
3P+E		6	CP20412547	300	126
3P+E+N		6	CP20512547	300	126
2P+E	500	7	CP20312557	300	126
3P+E		7	CP20412557	300	126
3P+E+N		7	CP20512557	300	126

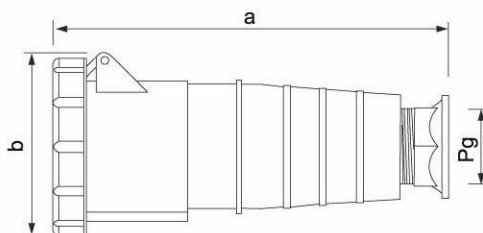



**16A**

POLES 極數	VOLTAGE 電壓	POS(E) E極	REF. 型號	DIMENSIONS 尺寸		
	V	h		a	b	MG
2P+E	110	4	CP30301617	154	82	25
3P+E		4	CP30401617	154	82	25
3P+E+N		4	CP30501617	154	82	25
2P+E	220	6	CP30301627	154	82	25
3P+E		9	CP30401627	154	82	25
3P+E+N		9	CP30501627	154	82	25
2P+E	400	9	CP30301647	154	82	25
3P+E		6	CP30401647	154	82	25
3P+E+N		6	CP30501647	154	82	25
2P+E	500	7	CP30301657	154	82	25
3P+E		7	CP30401657	154	82	25
3P+E+N		7	CP30501657	154	82	25

**32A**

2P+E	110	4	CP30303217	163	82	25
3P+E		4	CP30403217	163	82	25
3P+E+N		4	CP30503217	163	82	25
2P+E	220	6	CP30303227	163	82	25
3P+E		9	CP30403227	163	82	25
3P+E+N		9	CP30503227	163	82	25
2P+E	400	9	CP30303247	163	82	25
3P+E		6	CP30403247	163	82	25
3P+E+N		6	CP30503247	163	82	25
2P+E	500	7	CP30303257	163	82	25
3P+E		7	CP30403257	163	82	25
3P+E+N		7	CP30503257	163	82	25

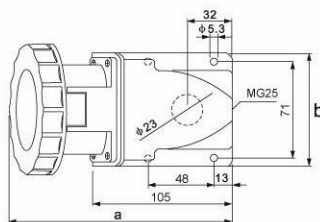

height=105  
 angle=15°





16A

POLES 極數	VOLTAGE 電 壓	POS(E) E 極	REF. 型 號	DIMENSIONS 尺 寸			
				a	b	k	sw
	V	h					
2P+E	110	4	CP20301617	129	76	6-15	38
3P+E		4	CP20401617	135	85	6-15	38
3P+E+N		4	CP20501617	142	89	8-16	42
2P+E	220	6	CP20301627	129	76	6-15	38
3P+E		9	CP20401627	135	85	6-15	38
3P+E+N		9	CP20501627	142	89	8-16	42
2P+E	400	9	CP20301647	129	76	6-15	38
3P+E		6	CP20401647	135	85	6-15	38
3P+E+N		6	CP20501647	142	89	8-16	42
2P+E	500	7	CP20301657	129	76	6-15	38
3P+E		7	CP20401657	135	85	6-15	38
3P+E+N		7	CP20501657	142	89	8-16	42

32A

2P+E	110	4	CP20303217	159	92	10-20	50
3P+E		4	CP20403217	159	92	10-20	50
3P+E+N		4	CP20503217	165	98	12-22	50
2P+E	220	6	CP20303227	159	92	10-20	50
3P+E		9	CP20403227	159	92	10-20	50
3P+E+N		9	CP20503227	165	98	12-22	50
2P+E	400	9	CP20303247	159	92	10-20	50
3P+E		6	CP20403247	159	92	10-20	50
3P+E+N		6	CP20503247	165	98	12-22	50
2P+E	500	7	CP20303257	159	92	10-20	50
3P+E		7	CP20403257	159	92	10-20	50
3P+E+N		7	CP20503257	165	98	12-22	50

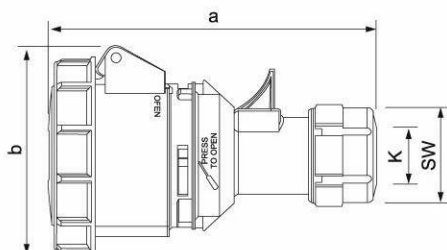



**16A**

POLES 極數	VOLTAGE 電壓	POS(E) E極	REF. 型號	DIMENSIONS 尺寸								
				a	b	c	d	e	f	g	h	i
2P+E	110	4	CP40301617	76	76	60	60	16	63	77	46	5.5
3P+E		4	CP40401617	76	76	60	60	18	63	83	53	5.5
3P+E+N		4	CP40501617	76	76	60	60	18	63	91	60	5.5
2P+E	220	6	CP40301627	76	76	60	60	16	63	77	46	5.5
3P+E		9	CP40401627	76	76	60	60	18	63	83	53	5.5
3P+E+N		9	CP40501627	76	76	60	60	18	63	91	60	5.5
2P+E	400	9	CP40301647	76	76	60	60	16	63	77	46	5.5
3P+E		6	CP40401647	76	76	60	60	18	63	83	53	5.5
3P+E+N		6	CP40501647	76	76	60	60	18	63	91	60	5.5
2P+E	500	7	CP40301657	76	76	60	60	16	63	77	46	5.5
3P+E		7	CP40401657	76	76	60	60	18	63	83	53	5.5
3P+E+N		7	CP40501657	76	76	60	60	18	63	91	60	5.5

**32A**

2P+E	110	4	CP40303217	76	76	60	60	22	76	97	60	5.5
3P+E		4	CP40403217	76	76	60	60	22	76	97	60	5.5
3P+E+N		4	CP40503217	76	76	60	60	22	76	104	60	5.5
2P+E	220	6	CP40303227	76	76	60	60	22	76	97	60	5.5
3P+E		9	CP40403227	76	76	60	60	22	76	97	60	5.5
3P+E+N		9	CP40503227	76	76	60	60	22	76	104	60	5.5
2P+E	400	9	CP40303247	76	76	60	60	22	76	97	60	5.5
3P+E		6	CP40403247	76	76	60	60	22	76	97	60	5.5
3P+E+N		6	CP40503247	76	76	60	60	22	76	104	60	5.5
2P+E	500	7	CP40303257	76	76	60	60	22	76	97	60	5.5
3P+E		7	CP40403257	76	76	60	60	22	76	97	60	5.5
3P+E+N		7	CP40503257	76	76	60	60	22	76	104	60	5.5

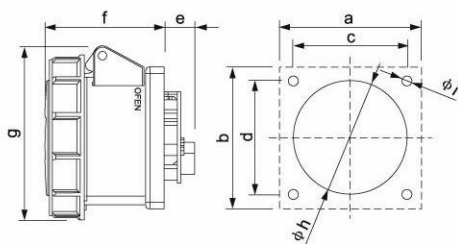





**16A**

POLES 極數	VOLTAGE 電 壓	POS(E) E 極	REF. 型 號	DIMENSIONS 尺 寸		
	V	h		a	b	MG
2P+E	110	4	CP31301614	144	82	25
3P+E		4	CP31401614	144	82	25
3P+E+N		4	CP31501614	144	82	25
2P+E	220	6	CP31301624	144	82	25
3P+E		9	CP31401624	144	82	25
3P+E+N		9	CP31501624	144	82	25
2P+E	400	9	CP31301644	144	82	25
3P+E		6	CP31401644	144	82	25
3P+E+N		6	CP31501644	144	82	25
2P+E	500	7	CP31301654	144	82	25
3P+E		7	CP31401654	144	82	25
3P+E+N		7	CP31501654	144	82	25

**32A**

2P+E	110	4	CP31303214	153	82	25
3P+E		4	CP31403214	153	82	25
3P+E+N		4	CP31503214	153	82	25
2P+E	220	6	CP31303224	153	82	25
3P+E		9	CP31403224	153	82	25
3P+E+N		9	CP31503224	153	82	25
2P+E	400	9	CP31303244	153	82	25
3P+E		6	CP31403244	153	82	25
3P+E+N		6	CP31503244	153	82	25
2P+E	500	7	CP31303254	153	82	25
3P+E		7	CP31403254	153	82	25
3P+E+N		7	CP31503254	153	82	25

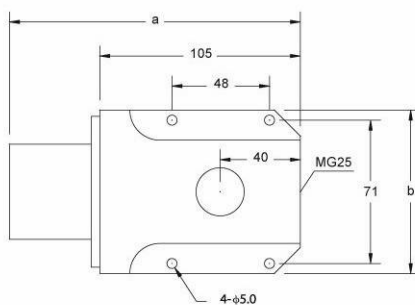



**63A**

POLES 極數	VOLTAGE 電壓	POS(E) E 極	REF. 型號	DIMENSIONS 尺寸						
				a	b	c	d	e	f	PG
2P+E	110	4	CP30306317	193	122	154	113	6	277	29
2P+E	220	6	CP30306327	193	122	154	113	6	277	29
3P+E		9	CP30406327	193	122	154	113	6	277	29
3P+E+N		9	CP30506327	193	122	154	113	6	277	29
2P+E	400	9	CP30306347	193	122	154	113	6	277	29
3P+E		6	CP30406347	193	122	154	113	6	277	29
3P+E+N		6	CP30506347	193	122	154	113	6	277	29
2P+E	500	7	CP30306357	193	122	154	113	6	277	29
3P+E		7	CP30406357	193	122	154	113	6	277	29
3P+E+N		7	CP30506357	193	122	154	113	6	277	29

**125A**

2P+E	110	4	CP30312517	260	152	241	140	8	333	36
2P+E	220	6	CP30312527	260	152	241	140	8	333	36
3P+E		9	CP30412527	260	152	241	140	8	333	36
3P+E+N		9	CP30512527	260	152	241	140	8	333	36
2P+E	400	9	CP30312547	260	152	185	130	8	333	36
3P+E		6	CP30412547	260	152	185	130	8	333	36
3P+E+N		6	CP30512547	260	152	185	130	8	333	36
2P+E	500	7	CP30312557	260	152	185	130	8	333	36
3P+E		7	CP30412557	260	152	185	130	8	333	36
3P+E+N		7	CP30512557	260	152	185	130	8	333	36

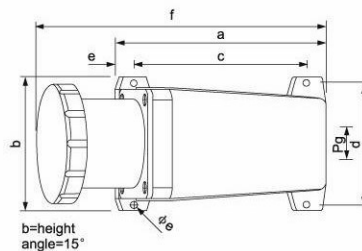





16A

POLES 極數	VOLTAGE 電 壓	POS(E) E 極	REF. 型 號	DIMENSIONS 尺 寸			
	V	h		a	b	k	sw
2P+E	110	4	CP11301617	120	71	6-15	38
3P+E		4	CP11401617	124	88	6-15	38
3P+E+N		4	CP11501617	131	95	8-16	42
2P+E	220	6	CP11301627	120	71	6-15	38
3P+E		9	CP11401627	124	88	6-15	38
3P+E+N		9	CP11501627	131	95	8-16	42
2P+E	400	9	CP11301647	120	71	6-15	38
3P+E		6	CP11401647	124	88	6-15	38
3P+E+N		6	CP11501647	131	95	8-16	42
2P+E	500	7	CP11301657	120	71	6-15	38
3P+E		7	CP11401657	124	88	6-15	38
3P+E+N		7	CP11501657	131	95	8-16	42

32A

2P+E	110	4	CP11303217	146	93	10-20	50
3P+E		4	CP11403217	146	93	10-20	50
3P+E+N		4	CP11503217	152	106	12-22	50
2P+E	220	6	CP11303227	146	93	10-20	50
3P+E		9	CP11403227	146	93	10-20	50
3P+E+N		9	CP11503227	152	106	12-22	50
2P+E	400	9	CP11303247	146	93	10-20	50
3P+E		6	CP11403247	146	93	10-20	50
3P+E+N		6	CP11503247	152	106	12-22	50
2P+E	500	7	CP11303257	146	93	10-20	50
3P+E		7	CP11403257	146	93	10-20	50
3P+E+N		7	CP11503257	152	106	12-22	50

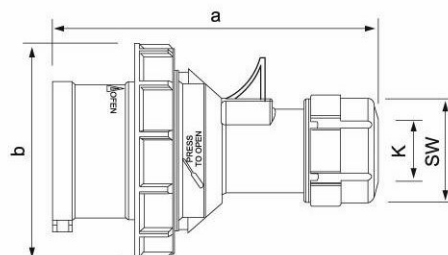



**16A**

POLES 極數	VOLTAGE 電壓	POS(E) E極	REF. 型號	DIMENSIONS 尺寸							
				a	b	c	d	e	f	g	h
	V	h									
2P+E	110	4	CP41301614	76	76	61	61	12	49	5.5	46
3P+E		4	CP41401614	76	76	61	61	12	49	5.5	53
3P+E+N		4	CP41501614	76	76	61	61	13	49	5.5	60
2P+E	220	6	CP41301624	76	76	61	61	12	49	5.5	46
3P+E		9	CP41401624	76	76	61	61	12	49	5.5	53
3P+E+N		9	CP41501624	76	76	61	61	13	49	5.5	60
2P+E	400	9	CP41301644	76	76	61	61	12	49	5.5	46
3P+E		6	CP41401644	76	76	61	61	12	49	5.5	53
3P+E+N		6	CP41501644	76	76	61	61	13	49	5.5	60
2P+E	500	7	CP41301654	76	76	61	61	12	49	5.5	46
3P+E		7	CP41401654	76	76	61	61	12	49	5.5	53
3P+E+N		7	CP41501654	76	76	61	61	13	49	5.5	60

**32A**

2P+E	110	4	CP41303214	76	76	61	61	13	58	5.5	62
3P+E		4	CP41403214	76	76	61	61	13	58	5.5	62
3P+E+N		4	CP41503214	76	76	61	61	13	58	5.5	68
2P+E	220	6	CP41303224	76	76	61	61	13	58	5.5	62
3P+E		9	CP41403224	76	76	61	61	13	58	5.5	62
3P+E+N		9	CP41503224	76	76	61	61	13	58	5.5	68
2P+E	400	9	CP41303244	76	76	61	61	20	58	5.5	60
3P+E		6	CP41403244	76	76	61	61	20	58	5.5	60
3P+E+N		6	CP41503244	76	76	61	61	20	58	5.5	60
2P+E	500	7	CP41303254	76	76	61	61	20	58	5.5	60
3P+E		7	CP41403254	76	76	61	61	20	58	5.5	60
3P+E+N		7	CP41503254	76	76	61	61	20	58	5.5	60

