









Temperature Controllers

From simple control to advanced control



Temperature Controller Selection Guide

		Color LCD			Compact	Plug & socket connection	
							
Model		PXF4	PXF5	PXF9	PXR3	PXR4	
Panel size in mm	96 × 96			✓			
	48 × 96		✓				
	48 × 48	✓				✓	
	48 × 24				✓		
Power supply	100–240 V AC	✓	✓	✓	✓	✓	
	24 V DC	✓	✓	✓	✓	✓	
Communication	RS-485 (Modbus)	✓	✓	✓	✓		
	RS-485 (Z-ASCII)				✓		
	Loader interface	✓	✓	✓			
Display		4-digit	4-digit	4-digit	4-digit	4-digit	
Electrical connection		M3 screw terminal, for wire with terminal lug			Euro-style terminal block, for bare wire or wire ferrule	8-pin or 11-pin, M3.5 screw terminal socket	
Reading accuracy		±0.2% FS	±0.2% FS	±0.2% FS	±0.5% FS	±0.5% FS	
Sampling time		50 ms	50 ms	50 ms	500 ms	500 ms	
Input	No. of PV input		1	1	1	1	
	Sensor	RTD	✓	✓	✓	✓	✓
		TC	✓	✓	✓	✓	✓
		Voltage/current	✓	✓	✓	✓	✓
		Thermistor					
	Options	Remote setpoint	✓	✓	✓		
		Current transformer	✓	✓	✓		
		Valve position		✓	✓		
Digital		≤ 3	≤ 3	≤ 3	≤ 2		
Output	Control output	Relay contact	✓	✓	✓	✓	
		SSR/SSC	✓ (SSR only)	✓ (SSR only)	✓ (SSR only)	✓	✓
		Linear current	✓	✓	✓	✓	✓
		Linear voltage	✓	✓	✓		
		Motor-operated valve	✓	✓	✓		
	Options	Transfer output (current)	✓	✓	✓	✓	
		Transfer output (voltage)	✓	✓	✓		
		Power to transmitter					
		Digital output	≤ 3	≤ 5	≤ 5	≤ 2	≤ 2
Control ※with auto-tuning	ON-OFF	✓	✓	✓	✓	✓	
	PID*	✓	✓	✓	✓	✓	
	Fuzzy*	✓	✓	✓	✓	✓	
	Self tuning	✓	✓	✓	✓	✓	
	PID 2*	✓	✓	✓			
	2-degree-of-freedom PID*	✓	✓	✓			
Others	Ramp soak	64 steps	64 steps	64 steps	8 steps	8 steps	
	No. of PID pallettes	8	8	8			
	No. of SVs	8	8	8	4		
	Manual operation	✓	✓	✓			
	User key	1	1	1			
Page		4-9	4-9	4-9	10-13	10-13	

Simple	High-end	Thermostat
		
PXE4	PXH9	PXR3
	✓	
✓		
✓	✓	✓
	✓	
✓	✓	
4-digit	5-digit	4-digit
M3 screw terminal, for wire with terminal lug		Euro-style terminal block, for bare wire or wire ferrule
±0.5% FS	±0.1% FS	±0.5% FS
200 ms	50 ms	2 s
1	2	1
✓	✓	
✓	✓	✓
	✓	
	✓	✓
✓	≤ 9	
✓ (SSR only)	✓	✓
	✓	
	✓	
	≤ 2	
	✓	
≤ 2	≤ 9	≤ 2
✓	✓	
✓	✓	
✓		
✓	✓	
	64 steps	
	7	
	7	
	✓	
	3	
14-15	16-19	22-23

Module Type Temperature Controllers	
 Common Specifications	
Size	30 (W) × 100 (H) × 85 (D) mm
Power supply	24 V DC
Accuracy	±0.3% FS
Sampling time	200 ms
Communication	RS-485 (MODBUS)
Loader communication	RS-232C (MODBUS)
Installation	Rail mount or wall mount
Control Module (PUMA/PUMB)	
No. of inputs	2 or 4
Sensor	TC, RTD, voltage/current
No. of outputs	2 or 4
Control output signal	Relay contact, current, SSR/SSC
Control	On/off, PID, heating/cooling
Auto, manual, remote	Auto, manual, remote
Options	CT input (4 or 8)
Event I/O Module (PUME)	
No. of DIs	8
No. of DOs	8
Output type	Relay contact or transistor
Analog I/O Module (PUMV/PUMN/PUMT)	
No. of AIs	4
Input signal	TC, RTD, voltage/current
No. of AOs	4
Output signal	4–20 mA DC
CC-Link Communication Module (PUMCL)	
Programless Communication with Mitsubishi PLC (PUMCM)	
PROFIBUS Communication Module (PUMCP)	
Ethernet Communication Module (PUMCE)	
Page	20-21

Micro-Controller X PXF

Superior Versatility and Flexibility for a Wide Range of Applications



Fast and Precise control

- Sampling time 50 ms
- Control 100 ms

Universal Input

- Accept any signal
- User can change the input type later on

Variety of Control Functions

- On-off
- PID
- Fuzzy
- Self-tuning
- PID2
- Two-degree-of-freedom PID
- Motor-operated-valve control

Compact Design

- Shallow body with 58-mm depth

Bus-Powered USB Interface

For configuration and data viewer software

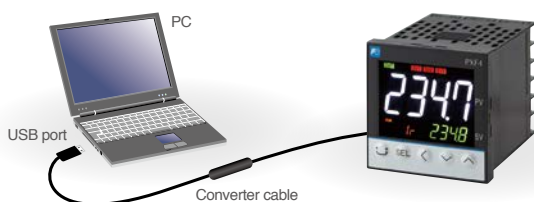

Easy-to-See Display

- Bright and clear color-LCD
- Tallest character height in market
- PV indication in white



Control Functions

On-Off Control Simple and Basic Control

When process value (PV) is below the set value (SV), PXF turns on the output to energize the heater, and vice versa. In this way, PXF keeps the temperature constant by turning the output on and off based on the SV as a threshold.

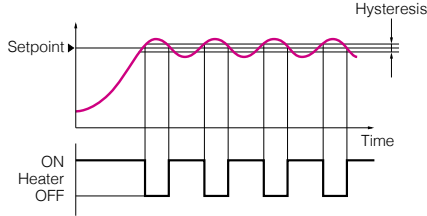

PID Control with Auto Tuning

Typical Control Based on PID Theory

The controller calculates optimal PID parameters. There are 2 types of auto-tuning functions; the standard type (auto-tuning with reference to SV) and the low-SV type (auto-tuning with reference to the value 10% below SV). The low-SV type auto tuning is useful when you want to avoid overshoots. You can also set the PID parameters manually.

PID Auto Tuning

(a) Standard type

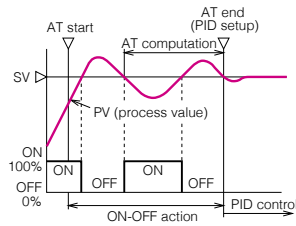

(b) Low-PV type

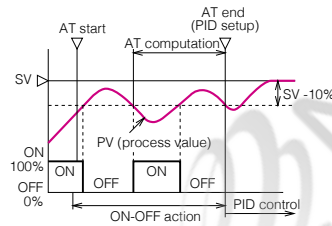

Molding Machine

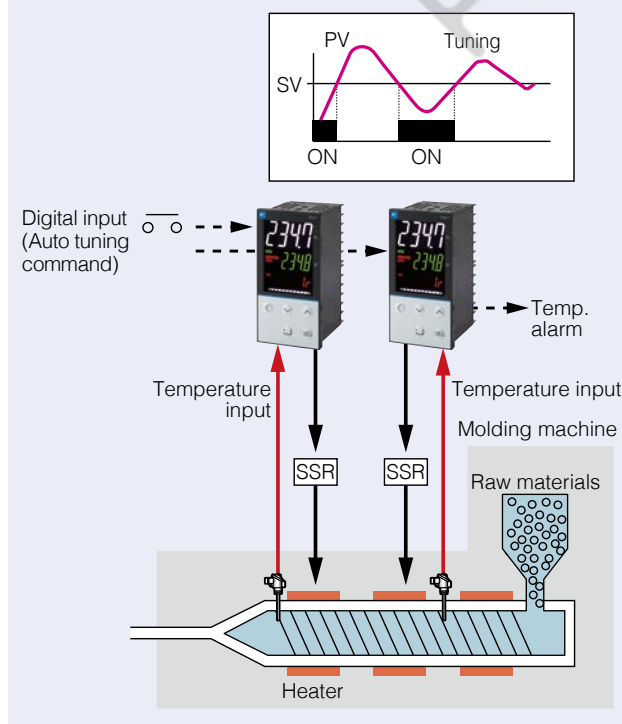

Fuzzy Control with Auto Tuning

Suppresses Overshoot by Fuzzy Calculation

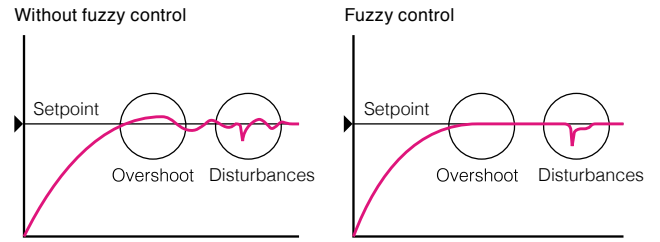

Self Tuning Control

For Changing Temperature

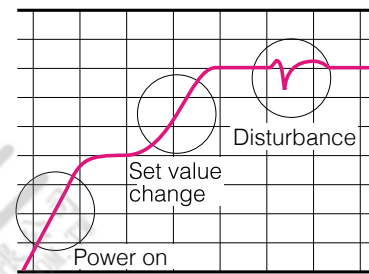

PID2 Control with Auto Tuning

Suppresses Overshoot and Undershoot

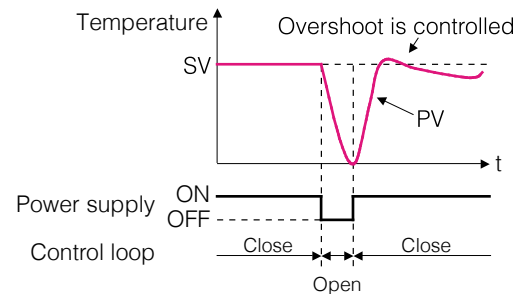

Two-Degree-of-Freedom PID Control with Auto Tuning

Combined Method for Stable Control

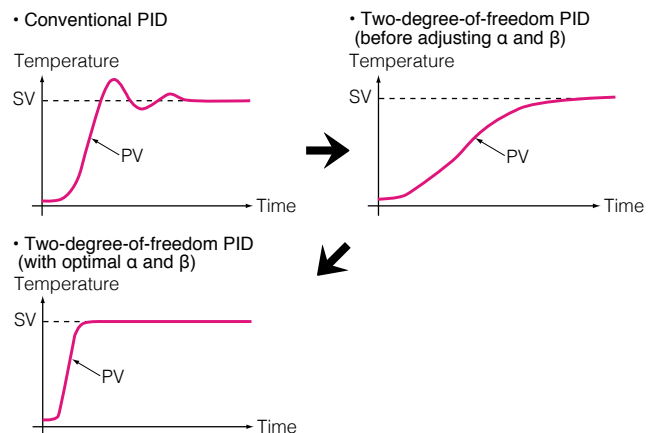

Functions for better user experience

Simple Program Control (Ramp Soak Function)

PXF automatically changes SV to the preset values at preset times. You can set up to 64 steps and 15 types of operation patterns. For example, when you bake four kinds of bread, you can divide 64 steps into four patterns to set suitable temperature for each bread. You can start/stop/suspend the operation using a user key, parameter setting, digital input, or communication.

■ Number of steps and patterns

Steps	Patterns
64	1
32	2
16	4
8	8

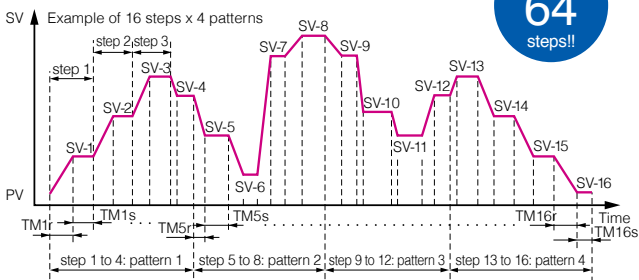

Controlling Temperature Gradient of Furnace by heating patterns

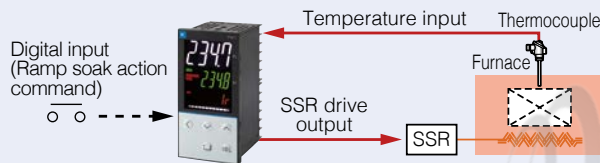

Heating and Cooling Control (option)

Motorized Valve Control

SV and PID selection Easy Switching Among 8 Presets

Enables optimum PID setting for changing process, materials, or PV. You can perform SV selection only, PID selection only, or PID selection according to PV.

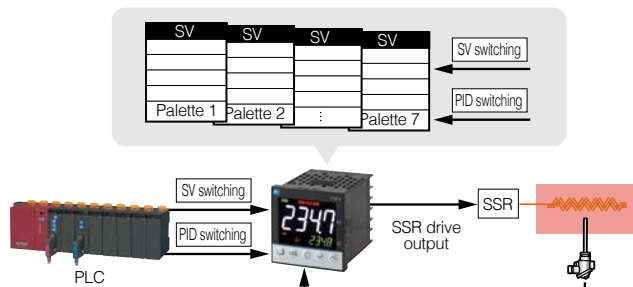

Simple Watt-Hour Metering Function

Tells You the Energy Consumption

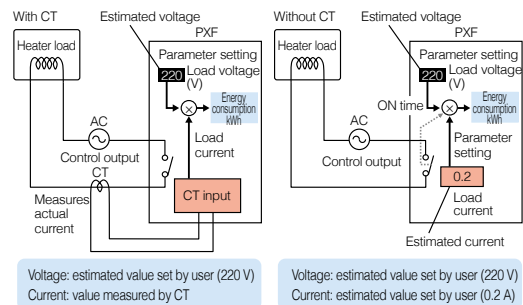

Operating Days Alarm

For Well-Timed Maintenance

Indicator or alarm output alert you when the number of days operated has reached the limit you set.



Soft Start

Saves Energy at Startup

RS-485 Communication (option)

Multi-drop master function in combination with the two-degree-of-freedom PID control enables synchronous heating control.

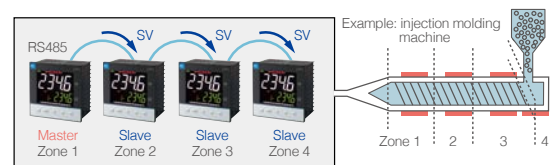

- Parameter values can be copied to multiple PXFs simultaneously.
- Communication with PC, HMI, or PLC

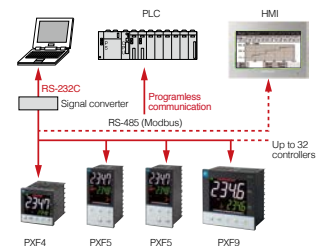

Heater Burnout Alarm (option)

Quickly Informs You a Failure

- A current transformer (CT) is required.
- The power supply voltage and the alarm action point must be configured beforehand.

Transfer Output (option)

Temperature Signals to External Devices

Alarm Output (option)

Up to 5 Alarms (PXF4: up to 3)

Digital Input (option)

SV Can be Switched Externally

Remote SV Input (option)

SV Can be Configured Externally

Specifications

General

Power supply voltage	100 V (-15%) to 240 V (+10%) AC, 50/60 Hz, or 24 V ($\pm 10\%$) AC/DC		
Power consumption	Model	100 to 240 V AC	24 V DC/AC
	PXF4	10 VA MAX.	5 VA MAX.
	PXF5 & PXF9	13 VA MAX.	8 VA MAX.
Insulation resistance	$\geq 20 \text{ M}\Omega$ (at 500 V DC)		
Withstand voltage	Between the power source and other terminals: 1500 V AC for 1 min		
	Between the relay output and other terminals: 1500 V AC for 1 min Others: 500 V AC for 1 min		
Input impedance	<ul style="list-style-type: none"> Thermocouple, mV input: $\geq 1 \text{ M}\Omega$ Current input: $\leq 150 \Omega$ (built-in diode) Voltage input: About 1 MΩ 		
Allowable input voltage	<ul style="list-style-type: none"> DC voltage input: $\leq \pm 35 \text{ V}$ Current input: $\leq \pm 25 \text{ mA}$ Thermocouple, RTD, mV input: $\leq \pm 5 \text{ V}$ 		
Effect of signal source resistance	<ul style="list-style-type: none"> Thermocouple, mV input: $\pm 0.3\% \text{ FS} \pm 1 \text{ digit}$ per 100 Ω Voltage input: $\pm 0.3\% \text{ FS} \pm 1 \text{ digit}$ per 500 Ω 		
Allowable wire resistance	RTD: $\leq 10 \Omega$ per wire		
Input value correction	(a) User adjustment: $\pm 50\% \text{ FS}$ for each of zero and span point		
	(b) Process value shift: $\pm 10\% \text{ FS}$		
	(c) Input filter: 0.0 to 120.0 s (filter is off when set to 0.0)		
	(d) Square root extraction: -0.1 to 105% (OFF if set to -0.1%)		
Noise reduction ratio	Normal mode: 40 dB (50/60 Hz)		
	Common mode: 120 dB (50/60 Hz)		
Temperature effect on sensitivity	Between input and power supply: $\pm 1^\circ \text{C}$ at 220 V AC, 50/60 Hz $\pm 0.3\% \text{ FS}$ per 10°C		

Display and keys

Type	Backlit LCD
Keys	5 embossed keys
Cotents	PV: 11-segment, 4-digit [white] SV: 11-segment, 4-digit [green] Parameter name: 7-segment, 4-digit [orange] Status indicator: ≤ 42
Luminance setting	4 levels
User key	Allows you to switch between: auto/manual, standby on/off, remote SV, ramp/soak, etc.

Structure

Installation	Panel mounting
Electrical connection	M3 screw terminal
Case	<ul style="list-style-type: none"> Material: ABS, PPO Non-combustibility grade: UL94V-0 equivalent Color: black
IP rating	<ul style="list-style-type: none"> Panel front side: IP66, NEMA-4X equivalent (When the panel is mounted using our genuine packing. Not water-proof if mounted closely together.) Body: IP20 equivalent (slits on top and bottom) Terminals: IP00 equivalent
Weight	PXF4: approx. 100 g, PXF5: approx. 170 g, PXF9: approx. 220 g

PV input

No. of inputs	1
Signal	Thermocouples, RTD, voltage, or current *See a separate table for measurement range.
Input setting	Programmable scale
Sampling rate	50 ms
Indication accuracy (at 23°C)	<ul style="list-style-type: none"> Thermocouple input: either $\pm 1^\circ \text{C} \pm 1 \text{ digit}$ or $\pm 0.3\%$ of indicated value $\pm 1 \text{ digit}$, whichever is larger *except: Thermocouple B: 0 to 400°C: no accuracy assurance Thermocouple R: 0 to 500°C: $\pm 3^\circ \text{C} \pm 1 \text{ digit}$ Thermocouples of which measuring range is between -200°C and -100°C: $\pm 2^\circ \text{C} \pm 1 \text{ digit}$ RTD input: $\pm 0.8^\circ \text{C} \pm 1 \text{ digit}$ or $\pm 0.2\%$ of indication value $\pm 1 \text{ digit}$, whichever is larger mV input, voltage input, current input: $\pm 0.3\% \text{ FS} \pm 1 \text{ digit}$
Overrange underrange	Out of the range between -5% and 105% FS (accuracy is not assured between -5 and 0, and between 100 and 105%FS) *Pt (-200°C to 850°C) input, 0-10 V DC input, thermocouple E: Out of the range between -5 to 102% of FS

Remote SV input (option)

No. of inputs	1
Signal	Voltage: 0-5 V DC, 1-5 V DC, 0-10 V DC Current (250 Ω resistor is required): 0-20 mA DC, 4-20 mA DC
Impedance	Approx. 1 M Ω
Sampling rate	50 ms

Current transformer input (option)

Input type	Single phase CT, 1 point For 1 A to 30 A: CTL-6-S-H For 20 A to 100 A: CTL-12-S36-8
Detection range	1 A to 100A
Accuracy	Setpoint $\pm 5\% \text{ FS}$
Resolution	0.1A
ON time necessary for detection	$\geq 300 \text{ ms}$

Digital input (option)

No. of inputs	PXF5 and PXF9: up to 3 PXF4 standard version: 1 PXF4 motorized valve control version: 3
Switch	Volt-free contact or transistor
Contact capacity	5 V DC, about 2 mA (per point)
Input judgment	ON voltage: 2 V DC or lower OFF voltage: 3 V DC or higher
Input pulse width	$\geq 50 \text{ ms}$
Functions	Remote mode selection, SV changeover, control standby, AT startup, timer startup, alarm unlatch, program selection, start/stop/reset, PID switching (normal/reverse), etc.

Valve position feedback signal input (option for PXF5 and PXF9 only)

Resistance range	100 Ω to 2.5k Ω , three-wire
Resolution	0.5% FS
Accuracy	$\pm 1.0\% \text{ FS}$
Temperature effect on sensitivity	$\pm 0.5\% \text{ FS}$ per 10°C
Burnout function	None

Alarm output (option)

No. of points	Relay contact Shared COM: PXF4: ≤ 3 , PXF5 & PXF9: ≤ 5 Independent COM: PXF4: ≤ 2 , PXF5 & PXF9: ≤ 3
Contact	<ul style="list-style-type: none"> Contact structure: SPST-NO Contact capacity: 250 V AC / 30 V DC, 1A (resistive load) Minimum ON/OFF current: 10 mA (5 V DC) Mechanical life: ≥ 20 million operations (100 operations/min) Electrical life: $\geq 100,000$ operations (rated load)
Functions	Alarm output, main unit control mode output, program status output, control output 1 and 2, etc.
Output cycle	100 ms

Alarm

No. of alarms	PXF4: ≤ 3 PXF5 & PXF9: ≤ 5 (depends on the number of DO)
Alarm type	Process value (upper limit/lower limit, absolute/deviation, range), device error, etc.(non-excitation, delay, latch, timer function available)
Heater current alarm function (option)	Current transformer (CT) is to be prepared separately Detectable range: 1 A to 100 A Detected current resolution: 0.1A Setting resolution: 0.1A Hysteresis: 0.0 to 100.0 A

Transfer output (option)

No. of points	1
Type	0-20 mA DC / 4-20 mA DC / 0-5 V DC / 1-5 V DC / 0-10 V DC / 2-10 V DC <ul style="list-style-type: none"> Guaranteed output range: 0-21 mA DC / 0-10.5 V DC Accuracy: $\pm 0.2\% \text{ FS}$ ($\pm 5\% \text{ FS}$ at 1 mA or smaller) Resolution: $\geq 10,000$ Load resistance: $\leq 500 \Omega$ (current), $\geq 10 \text{ k}\Omega$ (voltage)
Output cycle	100 ms
Contents	PV, SV, DV, MV
Additional function	Scaling function

Specifications

Control output

No. of points	≤ 2
Type	<ol style="list-style-type: none"> Relay contact output (SPST-NO) <ul style="list-style-type: none"> Proportional cycle: 1 to 150 s Contact capacity: 250 VAC / 30 VDC, 3A (resistive load) Minimum ON/OFF current: 10 mA (5 V DC) Mechanical life: ≥ 20 million operations (100 operations/min) Electrical life: ≥ 100,000 operations (rated load) Relay contact output (SPDT) <ul style="list-style-type: none"> Proportional cycle: 1 to 150 s Contact capacity: 250 VAC / 30 VDC, 5A (resistive load) Mechanical life: ≥ 20 million operations (100 operations/min) Electrical life: ≥ 100,000 operations (rated load) SSR drive output <ul style="list-style-type: none"> Proportional cycle: 1 to 150 s ON voltage: 12 V DC (between 10.7 and 13.2 V DC) OFF voltage: ≤ 0.5 V DC Maximum current: 20 mA DC Load resistance: ≥ 600 Ω Current output (0–20 mA DC / 4–20 mA DC) <ul style="list-style-type: none"> Accuracy: ±5%FS Load resistance: ≤ 500 Ω Voltage output (0–5 V DC / 1–5 V DC / 0–10 V DC / 2–10 V DC) <ul style="list-style-type: none"> Accuracy: ±5%FS Load resistance: ≥ 10 kΩ Motorized valve control output <ul style="list-style-type: none"> Contact structure: 2 SPST-NO contacts without interlock circuit Contact capacity: 250 VAC / 30 VDC, 3A (resistive load) Minimum ON/OFF current: 100 mA (24 V DC) Mechanical life: ≥ 20 million operations (100 operations/min) Electrical life: ≥ 100,000 operations (rated load)

Control

Control type	
On-off	
PID	
Fuzzy PID	Can be used in heating and cooling dual control. PID parameters are auto tuned.
PID2	
Self tuning	
Two-degree-of-freedom PID	PID parameters are auto tuned.
Position proportional PID (servo)	PXF4: without position feedback PXF5 and PXF9: with position feedback Full stroke time: ≥ 30 s
Control mode	Auto/Manual/Remote * In manual mode, on/off control is performed with 100% MV or 0% MV. Mode changeover: • Auto ↔ Manual: Balanceless · bumpless • Auto/Manual → Remote: Balance · bumpless • Auto/Manual ← Remote: Balance · bumpless
Parameters	
Proportional band (P)	0.1% to 999.9%
Integration time (I)	0 to 3200 s (invalidated when I = 0)
Differential time (D)	0.0 to 999.9 s (invalidated when D = 0)
Control cycle	100 to 900 ms (in 100 ms), 1 to 99 s (in seconds)
Anti-reset windup	0 to 100% of measurement range
Hysteresis band	50% of measurement range (for on/off action only)
Number of SV and PID patterns	8: Changed by any of parameter setting, digital input, communication, user function keying, zone change.

Measurement range

Input signal	Code (PvT)	Range [°C]	Resolution [°C]	
RTD	Pt 100	PT1	0.0 to 150.0	0.1
		PT2	0.0 to 300.0	0.1
		PT3	0.0 to 500.0	0.1
		PT4	0.0 to 600.0	0.1
		PT5	-50.0 to 100.0	0.1
		PT6	-100.0 to 200.0	0.1
		PT7	-199.9 to 600.0	0.1
		PT8	-200 to 850	1
DC voltage	0 to 5 V DC	0-5V	-1999 to 9999 (Range where scaling is allowed)	-
	1 to 5 V DC	1-5V		
	0 to 10V DC	0-10		
	2 to 10V DC	2-10		
DC current	0 to 100mV DC	MV		
	0 to 20 mA DC	0-20		
	4 to 20 mA DC	4-20		

RS-485 communication

Modbus RTU, half-duplex bit serial, asynchronous communication	
Serial characteristics	Data bits: 8 bits. Parity: odd, even, none Baud rate: 9600 bps, 19200 bps, 38.4 kbps, 115.2 kbps
Connection	≤ 32 units
Communication distance	≤ 500 m (total connection length)
Additional function	<ul style="list-style-type: none"> Multidrop master function The function in which slave devices can be operated by a master device by connecting several temperature controllers. <ul style="list-style-type: none"> Programless communication The function in which a temperature controller can be connected to a PLC without program. Supported PLCs: Mitsubishi PLC Q series Siemens PLC S7 series

Other functions

Ramp soak	64 steps × 1 pattern, 32 steps × 2 patterns, 16 steps × 4 patterns, or 8 steps × 8 patterns (1 step = 2 segments) - Control option: control by digital input or status output by digital output - Time setting: "Hour, Minutes" or "Minutes, Seconds" - Guaranteed soak - Repeat action - PV start - Delay start - Power failure recovery - Memory backup on EEPROM
Data backup at power outage	on non-volatile memory
Self-diagnosis	by watchdog timer
Password	three-level password
Simple watt-hour metering function	<ul style="list-style-type: none"> By connecting a current transformer (to be prepared separately), electric power consumption of the heater can be displayed. (Electric power is calculated based on the fixed voltage value you set.) Current transformer (CT) is to be prepared separately. Current detection range: 1 A to 100 A
Operating days alarm	<ul style="list-style-type: none"> Indicates the number of days the controller has been operated and activates alarm output (optional) when it exceeds the setpoint. Useful for preventive maintenance because it let you know the appropriate time for maintenance work.

Operation and storage conditions

Operating temperature	-10°C to 50°C
Storage temperature	-20°C to 60°C
Humidity	≤ 90% RH (no condensation)
Warm-up time	≥ 30 min
Vibration	during transportation: ≤ 9.8 m/s ² (1 G)
Impact	during transportation: ≤ 294 m/s ² (30 G)

Input signal	Code (PvT)	Range [°C]	Resolution [°C]	
Thermocouple	J	J1	0.0 to 400.0	0.1
		J2	-20.0 to 400.0	0.1
		J3	0.0 to 800.0	0.1
		J4	-100 to 1000	1
	K	K1	0 to 400	0.1
		K2	-20.0 to 500.0	0.1
		K3	0.0 to 800.0	0.1
		K4	-200 to 1300	1
	R	R	0 to 1700	1
		B	0 to 1800	1
	S	S	0 to 1700	1
		T	T1	-199.9 to 200.0
	T	T2	-199.9 to 400.0	0.1
		E	E1	0.0 to 800.0
	E	E2	-150.0 to 800.0	0.1
		E3	-200 to 800	1
L	L	-100 to 850	1	
U	U1	-199.9 to 400.0	0.1	
	U2	-200 to 400	1	
N	N	-200 to 1300	1	
W	W	0 to 2300	1	
PL-II	PL-2	0 to 1300	1	

Ordering Code

PXF4 Standard Type

Digit	Specification	Code
1-4	<Front dimensions W x H> 48 x 48mm	PXF4
5	-	A
6	<Control output 1> Relay contact (SPST) *1 Relay contact (SPDT) *1 SSR drive output	A B C
	Current output Voltage output	E P
	<Control output 2> None Relay contact (SPST) SSR drive output	Y A C
	Current output Voltage output Transfer output (current) Transfer output (voltage)	E P R S
	<Revision code>	2
9	<Alarm output> None 1 point 2 points 3 points 2 points (independent common)	0 1 F M J
	<Power supply voltage / instruction manual> 100 to 240 V AC, Japanese & English 100 to 240 V AC, English 100 to 240 V AC, Chinese & English 24 V AC/DC, Japanese & English 24 V AC/DC, English 24 V AC/DC, Chinese & English	Y V W A B D
	<Option> None RS-485 communication Digital input (DI1) RS-485 communication + Digital input (DI1) RS-485 communication + Remote SV input *2 RS-485 communication + CT input *3	1 M S V K J
	<Option> None RS-485 communication Digital input (DI1) RS-485 communication + Digital input (DI1) RS-485 communication + Remote SV input *2 RS-485 communication + CT input *3	1 M S V K J
	-	00

*1: Not available for the 7th code "C", "E", "P", "R", "S". However, if you want to order the 6th code "A" (SPST relay contact for the control output 1) and the 7th code "R" or "S" (current/voltage re-transmission output for the control output 2), specify the model as follows:

PXF4AA $\begin{matrix} \boxed{A} \\ \boxed{S} \end{matrix}$ 2-□□□02

*2: When using current for the remote SV input, add a 250-ohm resistor to the input terminal.

*3: When using the CT input for heater burnout alarm, add one alarm output for it in the 9th code.

PXF5 & PXF9 Standard Type

Digit	Specification	Code
1-4	<Front dimensions W x H> 48 x 96 mm 96 x 96 mm	PXF5 PXF9
5	-	A
6	<Control output 1> Relay contact (SPST) Relay contact (SPDT) SSR drive output	A B C
	Current output Voltage output	E P
	<Control output 2> None Relay contact (SPST) SSR drive output	Y A C
	Current output Voltage output Transfer output (current) Transfer output (voltage)	E P R S
	<Revision code>	2
9	<Alarm output> None 1 point 2 points 3 points 2 points (independent common)	0 1 F M J
	<Power supply voltage / instruction manual> 100 to 240 V AC, Japanese & English 100 to 240 V AC, English 100 to 240 V AC, Chinese & English 24 V AC/DC, Japanese & English 24 V AC/DC, English 24 V AC/DC, Chinese & English	Y V W A B D
	<Option> None RS-485 communication Digital input (DI 1 and DI2) Remote SV input + Digital input (DI3) *1 CT input + Digital input (DI1) *2 RS-485 communication + Digital input (DI1) RS-485 + Digital input (DI3, DI4, DI5) + Auxiliary alarm output (AL4, AL5)	1 M T H G V C
	<Option> None RS-485 communication Digital input (DI 1 and DI2) Remote SV input + Digital input (DI3) *1 CT input + Digital input (DI1) *2 RS-485 communication + Digital input (DI1) RS-485 + Digital input (DI3, DI4, DI5) + Auxiliary alarm output (AL4, AL5)	1 M T H G V C
	-	00

*1: When using current for the remote SV input, add a 250-ohm resistor to the input terminal.

*2: When using the CT input for heater burnout alarm, add one alarm output for it in the 9th code.

PXF4 Motorized Valve Control Type

Digit	Specification	Code
1-4	<Front dimensions W x H> 48 x 48mm	PXF4
5	-	A
6	<Control output 1> Motorized valve control output (without PFB input)	T
7	<Control output 2> None	Y
8	<Revision code>	2
9	<Alarm output> None 1 point 2 points 2 points (independent common)	0 1 F J
	<Power supply voltage / instruction manual> 100 to 240 V AC, Japanese & English 100 to 240 V AC, English 100 to 240 V AC, Chinese & English 24 V AC/DC, Japanese & English 24 V AC/DC, English 24 V AC/DC, Chinese & English	Y V W A B D
	<Option> None Digital input (DI 1, 2, 3) RS-485 communication + Digital input (DI1)	1 D V
	-	00

Separate order items

Current transformer	1 A to 30A 20 to 100A	ZOZ*CCTL-6-S-H ZOZ*CCTL-12-S36-8
Terminal cover		ZZPPXR1-A230
Parameter loader interface cable		ZZP*QT501923C3
Shunt resistor (250 Ω±0.1%)		ZZPPXR1-A190
Panel mounting adapter for replacement from PXR7 to PXF4		ZZP*QT502732C1

PXF5 & PXF9 Motorized Valve Control Type

Digit	Specification	Code
1-4	<Front dimensions W x H> 48 x 96 mm 96 x 96 mm	PXF5 PXF9
5	-	A
6	<Control output 1> Motorized valve control output (without PFB input) Motorized valve control output (with PFB input)	S V
7	<Control output 2> None	Y
8	<Revision code>	2
9	<Alarm output> None 1 point 2 points 3 points 2 points (independent common)	0 1 F M J
	<Power supply voltage / instruction manual> 100 to 240 V AC, Japanese & English 100 to 240 V AC, English 100 to 240 V AC, Chinese & English 24 V AC/DC, Japanese & English 24 V AC/DC, English 24 V AC/DC, Chinese & English	Y V W A B D
	<Option> None RS-485 communication + Digital input (DI1, DI2, DI3)	1 U
	-	00

Separate order items

Current transformer	1 A to 30A 20 to 100A	ZOZ*CCTL-6-S-H ZOZ*CCTL-12-S36-8
Terminal cover *1		ZZPPXF1-B100
Parameter loader interface cable		ZZP*QT501923C3
Shunt resistor (250 Ω±0.1%)		ZZPPXR1-A190

*1: For PXF9, two covers are necessary for one unit.

Scope of delivery

Controller, panel mounting adapter, water-proof packing, instruction manual

Micro-Controller X PXR



PXR4
48 × 48 × 84.7 mm



PXR3
48 × 24 × 98 mm



Compact Type and Plug & Socket Connection type

- Heating and cooling control
- Front waterproof structure
- Sampling time 500ms
- 2 DI + 2 DOs available
- Options: alarm, RS-485 communication, transfer output, ramp soak

Energy-efficient air conditioning system

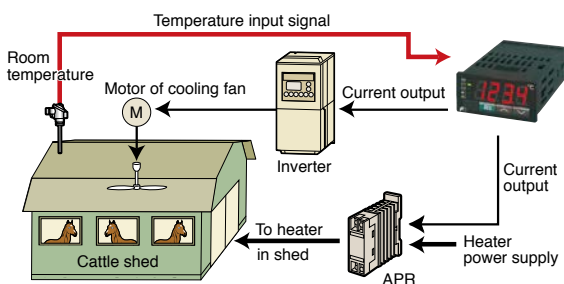

Optimal control of multiple heating devices

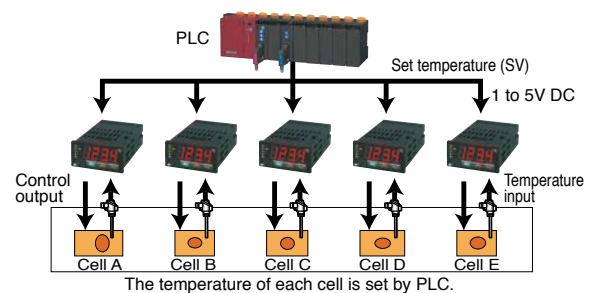

PXR3 and PXR4

Control Functions

Auto-Tuned Fuzzy Control

PXR monitors the process temperature and suppress overshoot and effect of external disturbances based on the fuzzy logic, without increasing the startup time.

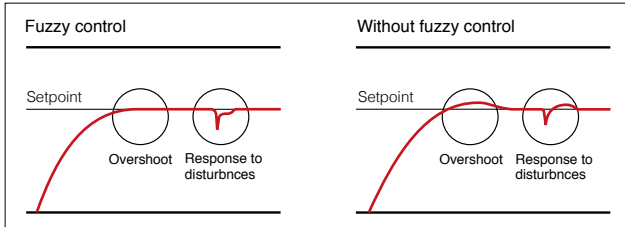

On-Off Control

The temperature controller keeps the temperature stable by turning on the power supply for a heater when the process value is lower than the setpoint, and turning it off when the process value is higher than the setpoint. The controller works in on-off control if you set the parameter P to zero.

Heating / Cooling Control (option for PXR3)

By using two control outputs, you can control both heating process and cooling process with a single controller.

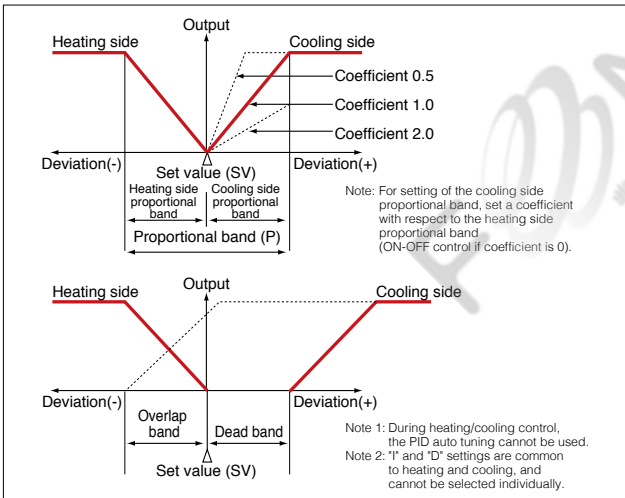

Auto-Tuned PID Control

The controller calculates optimal PID parameters. There are 2 types of auto-tuning functions; the standard type (auto-tuning with reference to SV) and the low-SV type (auto-tuning with reference to the value 10% below SV). The low-SV type auto-tuning is useful when you want to avoid overshoots. You can also set the PID parameters manually.

(a) Standard type

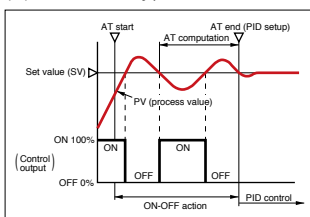

(b) Low-PV type

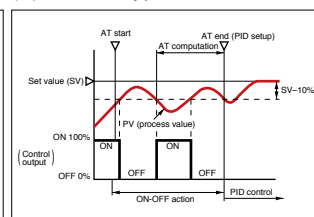

Self-Tuned PID Control

The controller tunes PID parameters when necessary; for example, at startup of the equipment, when the setpoint is changed, and/or the process temperature changed due to disturbance.

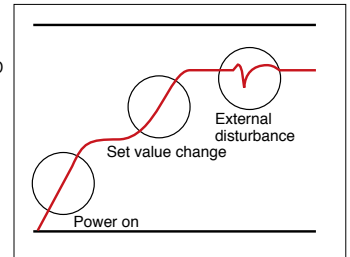

Note: For some objects to control, PID values could not be optimized.

Ramp Soak Control (option)

PXR automatically changes the setpoint to the preset values at preset times. You can set up to 64 steps and 15 patterns.

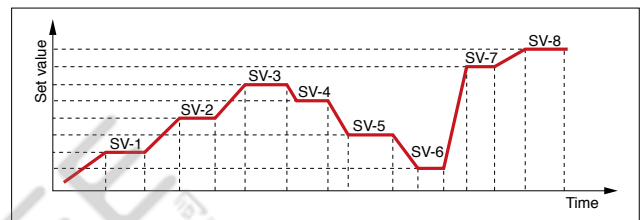

RS-485 Communication (option for PXR3)

Allows the temperature controller to communicate with a PC, PLC, or HMI.

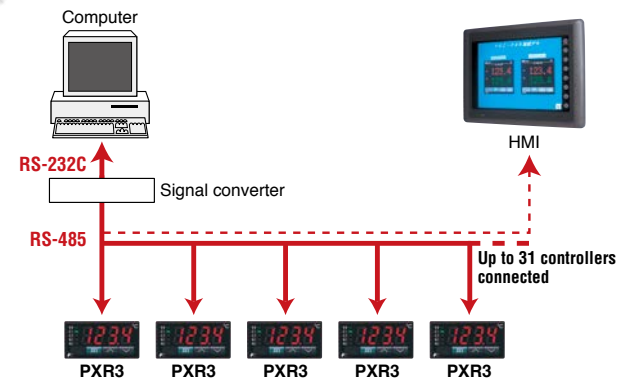

Transfer Output (option for PXR3)

PXR3 can send SV, PV, MV, or deviation of PV and SV, as 4-20 mA signal to an external device such as a recorder. Allows you to save the cost for a temperature sensor for recorder.

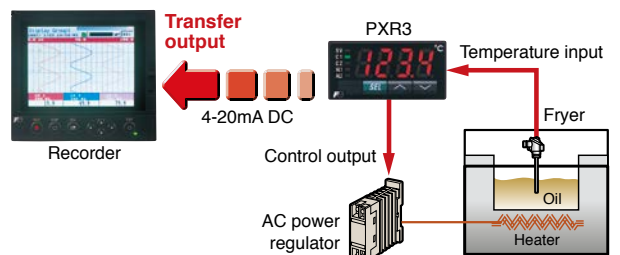

PXR3 and PXR4

Specifications

General

Power supply voltage	100 V (-15%) to 240 V (+10%) AC, 50/60 Hz, or 24 V ($\pm 10\%$) AC/DC
Power consumption	100 V AC: ≤ 6 VA (PXR3), ≤ 8 VA (PXR4) 220 V AC: ≤ 8 VA (PXR3), ≤ 10 VA (PXR4) 24 V AC/DC: ≤ 8 VA (PXR3), ≤ 10 VA (PXR4)
Insulation resistance	≥ 20 M Ω (at 500 V DC)
Withstand voltage	Between the power source and the ground terminal: 1500 V AC for 1 min Between the power source and others: 1500 V AC for 1 min Between the ground and relay outputs: 1500 V AC for 1 min Others: 500 V AC for 1 min
Input impedance	Thermocouple, mV input: ≥ 1 M Ω Current: 250 Ω (external resistor) Voltage: ≥ 450 k Ω
Allowable signal source resistance	Thermocouple: ≤ 100 Ω Voltage: ≤ 1 k Ω
Allowable wire resistance	RTD: ≤ 10 Ω per wire
Input value correction	Process value shift: $\pm 10\%$ FS Input filter: 0 to 900.0 s settable in 0.5 s steps (first order lag filter)
Noise reduction ratio	Normal mode noise (50/60 Hz): ≥ 50 dB Common mode noise (50/60 Hz): ≥ 140 dB

Display and keys

Type	LED, 3 keys
Contents	SV and PV: 4 digits, 7-segment (PXR3: SV/PV switching, PXR4: SV/PV independent display) Status indicator: control output, alarm

Structure

Installation	Panel flush mounting Can be mounted to rail/wall by using the DIN rail mounting adapter available as option.
Electrical connection	PXR3: euro-style terminal PXR4: 8-pin or 11-pin, M3.5 screw terminal socket
Case	Plastic (non-combustible grade UL94V-0 equivalent), black
IP rating	Front waterproof structure: NEMA4X (IP66 equivalent) *When mounted on panel with our genuine packing. Waterproof feature unavailable in close mounting of multiple units. Rear case: IP20
Weight	Approx. 150 g (PXR3), 200 g (PXR4)

Control output

	Control output 1	Control output 2 (option for PXR3, for cooling/heating control)
Type	Select one of the followings: • Relay contact (PXR3: SPST-NO, PXR4: SPDT): 220 VAC / 30 VDC, 3A (resistive load) Mechanical life: 10 million operations (no load) Electrical life: 100,000 operations (rated load) Minimum switching current: PXR3: 10 mA (5 VDC), PXR4: 100 mA (24 VDC) • SSR / SSC drive (voltage pulse): ON: PXR3: 12–16 V DC, PXR4: 17–25 VDC OFF: ≤ 0.5 V DC Maximum current: 20 mA • 4–20 mA DC: Allowable load resistance: PXR3: 100–500 Ω , PXR4: ≤ 600 Ω	Select one of the followings: • Relay contact: SPST-NO, 220 VAC / 30VDC, 3A (resistive load) Mechanical life: 10 million operations (no load) Electrical life: 100,000 operations (rated load) Minimum switching current: 10 mA (5 V DC) • SSR/SSC drive (voltage pulse): ON: 12–16 V DC OFF: ≤ 0.5 V DC Maximum current: 20 mA • 4 to 20 mA DC: Allowable load resistance: 100–500 Ω
Control type	PID control (with auto tuning, self-tuning) Fuzzy control (with auto tuning)	PID control (with auto tuning)
Parameters	On/off action if P = 0. Proportional action when I, D = 0.	P,I,D=0: ON/OFF action (without dead band) for heating and cooling I,D=0: Proportional action
Proportional band (P)	0 to 999.9% of measuring range settable in 0.1% steps	Heating side: 0 to 999.9 % of measuring range Cooling side: Heating side "P" \times cooling side coefficient Cooling side proportional band coefficient: 0 to 100.0 On/off action if P=0
Integration time (I)	0 to 3200 s settable in 1 s steps	0 to 3200 s
Differential time (D)	0 to 999.9 s settable in 0.1 s steps	0 to 999.9 s
Proportional cycle	1 to 150 s settable in 1 s steps Only for relay contact output or SSR/SSC drive output	1 to 150 s Only for relay contact output or SSR/SSC drive output only
Control cycle	0.5 s	0.5 s
Anti-reset windup	0 to 100% of measuring range Automatically validated at auto tuning	0 to 100% of measuring range Automatically validated at auto tuning
Hysteresis band	0 to 50% of measuring range For on/off action only	50% of measuring range common to heating and cooling sides, For on/off action only
Overlap dead band	—	$\pm 50\%$ of heating side proportional band

PV input

No. of inputs	1
Signal	Thermocouples, RTD, voltage, or current *See a separate table for measurement range.
Sampling rate	0.5 s
Indication accuracy(at 23°C)	Thermocouple: $\pm(0.5\%$ of measuring range) ± 1 digit $\pm 1^\circ\text{C}$ For thermocouple R at 0 to 500°C: $\pm(1\%$ of measuring range) ± 1 digit $\pm 1^\circ\text{C}$ For thermocouple B at 0 to 400°C: $\pm(5\%$ of measuring range) ± 1 digit $\pm 1^\circ\text{C}$ RTD, voltage/current: $\pm(0.5\%$ of measuring range) ± 1 digit
Burnout	In the thermocouple input version or the RTD input version, a user can select either the upper or the lower limit to which the control output should go when a sensor burnout occurs.

Digital input (option for PXR3)

No. of inputs	≤ 2
Switch	Volt-free contact or transistor
Contact capacity	5 V DC, about 2 mA (per point)
Input judgment	ON voltage: ≤ 2 V DC OFF voltage: ≥ 3 V DC
Input pulse width	≥ 0.5 s
Functions	Set value (front SV, SV1 to 3) changeover Control action start / stop Ramp/soak action start / reset Auto tuning start / stop Alarm latch cancel Alarm on- or off-delay timer: setting range 0–9999 s in 1 s steps

Alarm output

No. of alarms	≤ 2
Alarm type	Absolute alarm, deviation alarm, zone alarm with upper and lower limits for each Hold function available Alarm latch, Excitation/non-excitation selecting function provided
Alarm ON-delay	Delay setting 0 to 9999 s settable in 1 s steps
Contact	Relay contact (SPST-NO): 220 VAC / 30 VDC, 1 A (resistive load) Mechanical life: 10 million operations (no load) Electrical life: 100,000 operations (rated load) Minimum switching current: 10 mA (5 V DC). Output cycle: 0.5 s

Transfer output (option for PXR3)

No. of points	1
Type	4-20 mA DC • Load resistance: ≤ 500 Ω • Accuracy: ±0.3%FS at 23°C • Resolution: ≥ 2000
Output cycle	500 ms
Contents	PV, SV, DV, MV

RS-485 communication (option for PXR3)

Modbus RTU or Z-ASCII, two-wire, half-duplex bit serial, asynchronous communication	
Serial characteristics	Data bits: 8 bits. Parity: odd, even, none Baud rate: 9600 bps
Connection	≤ 32 units, multi drop
Communication distance	≤ 500 m (total connection length)
Recommended RS-232C RS-485 converter	Isolated type Manufacturer: OMRON Co., Ltd. (Japan) Model: K3SC-10

Other functions

Ramp soak (option)	2 program pattern of 4 steps each, or 1 program pattern × 8 steps On PXR3, a user can use the digital input to start/reset the ramp soak action.
Data backup at power outage	on non-volatile memory
Self-diagnosis	by watchdog timer

Operation and storage conditions

Operating temperature	-10°C to 50°C
Storage temperature	-20°C to 60°C
Humidity	≤ 90% RH (no condensation)

Measurement range

	Input signal	Range(°C)	Range(°F)
RTD	Pt100	-150 to 850*	-238 to 1562
	J	0 to 800	32 to 1472
	K	0 to 1200	32 to 2192
	R	0 to 1600	32 to 2912
	B	0 to 1800	32 to 3272
Thermocouple	S	0 to 1600	32 to 2912
	T	-150 to 400	-238 to 752
	E	-150 to 800	-238 to 1472
	N	0 to 1300	32 to 2372
	PLII	0 to 1300	32 to 2372
	DC voltage	1 to 5V	scaling range
DC current	4 to 20mA		

- For 4-20 mA current input, add the provided 250-ohm resistor to the input terminal.
- For temperatures of 1000°C (1832°F) or above, the decimal point does not appear on the display.
- By editing the parameter, you can switch the input type setting among RTD and thermocouples, or between voltage and current.

Ordering Code

PXR

4	5	6	7	8
3				2

 -

9	10	11	12	13	14
					F

Digit	Specification	Code
4	<Front dimensions W x H> 48 x 24 mm	3
5	<Input signal> Thermocouple °C	T
	Thermocouple °F	R
	RTD Pt100 Ω 3-wire °C	N
	RTD Pt100 Ω 3-wire °F	S
	1 to 5 V DC 4 to 20 mA DC	A B
6	<Control output 1> Relay contact output SSR/SSC driving output 4 to 20 mA DC output	A C E
	<Control output 2> None	Y
	Relay contact output*1 SSR/SSC driving output*1 4 to 20 mA DC output*1	A C E
8	<Revision code>	2
9	<Option 1> None	0
	Alarm 1 point	1
	Ramp soak	4
	Alarm 1 point + ramp soak	5
	Alarm 2 points*2 Alarm 2 points + ramp soak*2	F G
10	<Instruction Manual><Power supply voltage> None 100 to 240 V AC	N
	English 100 to 240 V AC	V
	None 24 V AC/DC	C
	English 24 V AC/DC	B
11 12	<Option 2> None	000
	RS-485 Modbus interface	M00
	RS-485 Z-ASCII interface	N00
	Transfer output + Digital input 1 point*3	Q00
	Transfer output*3	R00
	Digital input 2 points	T00
	RS-485 Modbus interface + Digital input 1 point RS-485 Z-ASCII interface + Digital input 1 point	V00 W00
14	Non-standard parameter setting	F

PXR

4	5	6	7	8
4		S	1	

 -

9	10	11	12	13

Digit	Specification	Code
4	<Front dimensions> 48 x 48mm	4
5	<Input signal> Thermocouple °C	T
	Thermocouple °F	R
	RTD Pt100 3-wire type I (°C)*1	N
	RTD Pt100 3-wire type I (°F)*1	S
	1 to 5V DC 4 to 20mA DC	A B
	RTD Pt100 3-wire type II (°C)*2	W
6	<Control output 1> Relay contact output Voltage pulse output (24V DC) 4 to 20mA DC output	A C E
	<Terminal> Socket type	S
	8	<Revision code>
9	<Option> None	0
	Alarm 1point	1
	Ramp soak	4
	Alarm 1point + ramp soak	5
	Alarm 2points Alarm 2points + ramp soak	F G
10	<Instruction manual> <Power supply voltage> None 100 to 240V AC	N
	English 100 to 240V AC	V
	None 24V AC/DC	C
	English 24V AC/DC	B
11 12 13	<Socket> None	000
	For rail mounting (8-pin) Type: TP48X	100
	For panel mounting (8-pin) Type: TP48SB	200
	For rail mounting (11-pin) Type: TP411X	400
	For panel mounting (11-pin) Type: TP411SBA	500

Separate order items

Shunt resistor (250 Ω ±0.1%)	ZZPPXR1-A190
------------------------------	--------------

Scope of delivery

Controller, panel mounting bracket, watertight packing, 250 ohm resistor(for current input), instruction manual

Separate order items

DIN rail mounting adapter (for PXR3)	ZZR*CTK368715P1
--------------------------------------	-----------------

Micro-Controller X PXE



48 × 48 × 63.5 mm



Simple and Easy

- 1.6-mm shallow and waterproof front panel
- A user can switch input type among Pt100 RTD and 9 types of thermocouples and their measuring range with front keys
- On-off, PID, and fuzzy control
- Relay contact output or SSR drive output
- Up to two alarm outputs



Specifications

General

Power supply voltage	100 V (-15%) to 240 V (+10%) AC, 50/60 Hz
Power consumption	100 V AC: ≤ 5 VA 220 V AC: ≤ 6 VA
Insulation resistance	≥ 20 MΩ (at 500 V DC)
Withstand voltage	Between the power supply and others: 1500 V AC for 1 min *SSR driving output is not isolated from input terminals.
Input impedance	Thermocouple: ≥ 1 MΩ
Allowable signal source resistance	Thermocouple: ≤ 100Ω
Allowable wire resistance	RTD: ≤ 10 Ω per wire
Input value correction	Process value shift: ±10% FS Input filter: 0 to 120.0 s settable in 0.1 s steps (first order lag filter)
Noise reduction ratio	Normal mode noise (50/60 Hz): ≥ 40 dB Common mode noise (50/60 Hz): ≥ 120 dB

Display and keys

Type	LED
Keys	4 keys
Cotents	PV and SV: 4 digits, 7-segment Status indicator: control output, alarm, standby

Structure

Installation	Panel flush mounting
Electrical connection	M3 screw terminal
Case	Plastic (non-combustible grade UL94V-0 equivalent) Color: black
IP rating	Front waterproof structure: NEMA4X (IP66 equivalent) (When mounted on panel with our genuine packing. Waterproof feature unavailable in close mounting of multiple units.) Rear case: IP20
Weight	Approx. 100g

PV input

No. of inputs	1
Signal	Thermocouples or RTD *See a separate table for measurement range.
Sampling rate	0.2 s
Indication accuracy (at 23°C)	(±0.5% of process value or 1°C whichever is greater) ±1digit±1°C •Thermocouple -100°C or less : (±2% of process value) ±1digit±1°C •Accuracy is not assured for ranges from 0 to 500°C for type R thermocouple and from 0 to 400°C for type B thermocouple.
Burnout	A user can select either the upper or the lower limit to which the control output should go when a sensor burnout occurs.

Control output 1

No. of points	1
Type	Select either of the followings: •Relay contact (SPST-NO): 220 VAC / 30 VDC, 3A (resistive load) Electrical life: 100,000 operations (rated load) Minimum switching current: 100 mA (24 VDC) •SSR drive (Voltage pulse): ON: 10.2–15 V DC OFF: ≤ 0.5 V DC Maximum current: 20 mA

Alarm or control output 2 (option)

No. of alarms	≤ 2
Alarm type	Absolute alarm, deviation alarm, zone alarm with upper and lower limits for each Hold function available Alarm latch, excitation/non-excitation selecting function
Alarm ON-delay	0 to 9999 s, settable in 1 s steps
Contact	Relay contact: SPST-NO, 220 V AC/30 V DC, 1 A (resistive load) Electrical life: 100,000 operations (rated load) Minimum switching current: 100 mA (5 V DC) Output cycle: 0.2 s

*In the heating and cooling dual control, the alarm output 1 functions as the control output 2.

Control

Control type	On-off, PID, fuzzy, two-degree-of-freedom PID
Parameters	
Proportional band (P)	0.1 to 999.9% of measuring range settable in 0.1% steps
Integration time (I)	0 to 3200 s settable in 1 s steps
Differential time (D)	0 to 999.9 s settable in 0.1 s steps
	Proportional action when I, D = 0.
Proportional cycle	1 to 150 s, settable in 1 s steps
Control cycle	0.2 s
Anti-reset windup	0 to 100% of measuring range Automatically validated at auto tuning
Hysteresis band	0 to 50% of measuring range For on-off action only

Other functions

Data backup at power outage	on non-volatile memory
Self-diagnosis	by watchdog timer

Operation and storage conditions

Operating temperature	-10°C to 50°C
Storage temperature	-20°C to 60°C
Humidity	≤ 90% RH (no condensation)

Measurement range

Input signal		Range(°C)
RTD	PT1	-200 to 850
	PT2	-199.9 to 500.0
Thermocouple	J1	0 to 800
	J2	0.0 to 400.0
	K1	0 to 400
	K2	-200 to 1200
	K3	0.0 to 400.0
	T1	-200 to 400
	T2	-199.9 to 400.0
	R	0 to 1600
	B	0 to 1800
	S	0 to 1600
E	-200 to 800	
N	0 to 1300	
PL-2	0 to 1300	

Ordering Code

P X E ⁴ ⁵ ⁶ ⁷ ⁸ - ⁹ ¹⁰ ¹¹ ¹² ¹³ ¹⁴
 4 T Y 2 - Y 0 0 0 - E

Digit	Specification	Code
4	<Front dimensions> 48 x 48mm	4
5	<Input signal> Thermocouple, RTD Pt100 [°C]	T
6	<Control output> Relay contact output SSR drive output	A C
7	-	Y
8	<Revision code>	2
9	<Alarm output> 1 point 2 points 2 points (independent COM)	1 2 J
10	<Instruction manual> Japanese/English/Chinese	Y

Scope of delivery

Controller, panel mounting bracket, watertight packing, instruction manual

Separate order item

Terminal cover | ZZPPXR1-A230

Digital Controller

PXH



96 × 96 × 81.5 mm



High Speed and High Accuracy

- Fast sampling: 50 ms
- Reading accuracy: 0.1%
- 5-digit display can show hundredths place
- Universal input (up to 2 points)
- 9 DI + 9 DO
- 1 AI + 2AO
- Relay contact, SSR/SSC drive, 4–20 mA DC, or motor-operated valve control output
- 64 steps ramp soak function
- Math function
- Pre-installed program templates
- RS-485 communication

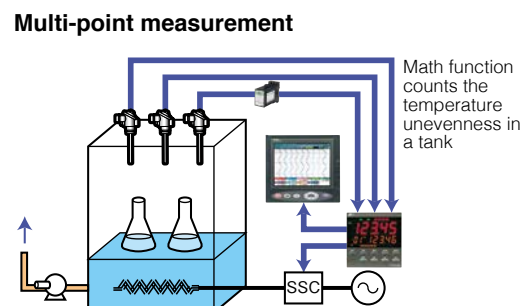
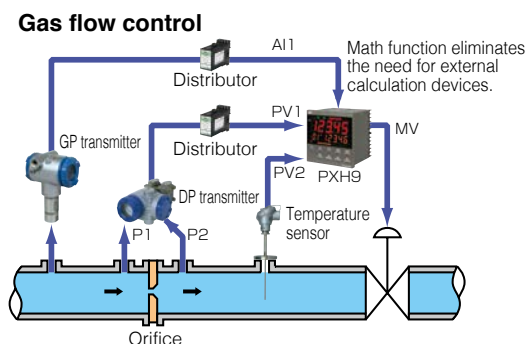

Control Functions

Two-Degree-of-Freedom PID

Suppresses overshoot and undershoot occurs at startup or at SV change, or due to disturbances.

• Normal PID

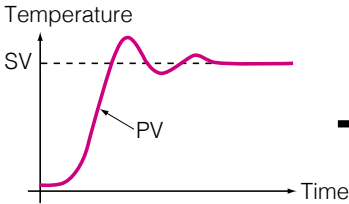

• Two-degree-of-freedom PID (before adjusting α and β)

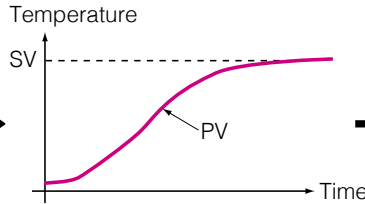

• Two-degree-of-freedom PID (with optimal α and β)

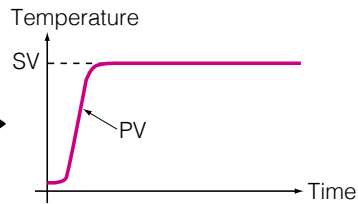

PID Palette

PID palette is pre-installed program templates that allow easy configuration for various applications. You can switch among seven palettes by the following three methods.

- Automatic switching according to PV
- SV switching

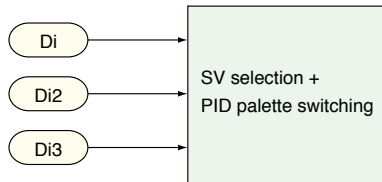

- Manually (by changing parameter)

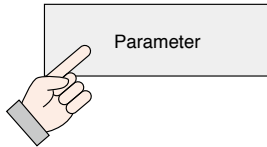

Recipe

A user can add up to 10 parameters to each PID palette. This allows more optimal batch process control.

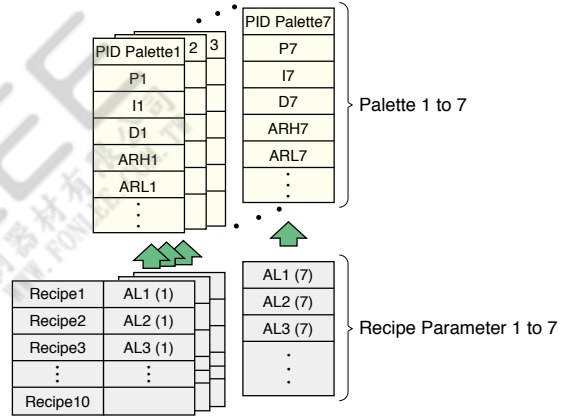

Totalizer

By combining the analog totalizer with the calculation function, you can obtain the flow rate after temperature and pressure compensation.

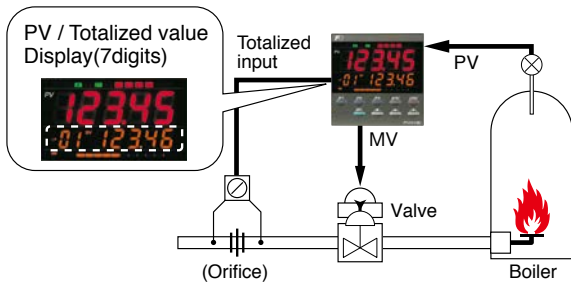

User Key

PXH has three user keys to which you can allocate various functions.

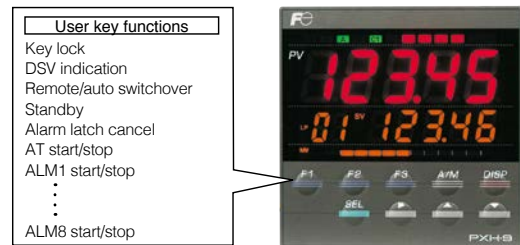

Specifications

General

Power supply voltage	100V AC (-15%) to 240 V AC (+10%), 50/60 Hz
Power consumption	100 V AC: ≤ 15 VA 220 V AC: ≤ 20 VA
Insulation resistance	≥ 20 MΩ (at 500 V DC)
Withstand voltage	Between the power source and other terminals: 1500 V AC for 1 min Between the relay output and other terminals: 1500 V AC for 1 min Others: 500 V AC for 1 min
Input impedance	<ul style="list-style-type: none"> Thermocouple, mV input: ≥ 1 MΩ Current input: 250 Ω Voltage input: 1 MΩ
Allowable input voltage:	<ul style="list-style-type: none"> DC voltage input: ≤ ±35 V Current input: ≤ ±25 mA Thermocouple, RTD, mV input: ≤ ±5 V
Effect of signal source resistance	<ul style="list-style-type: none"> Thermocouple, mV input: ±0.1%FS per 100 Ω Voltage input: ±0.1%FS per 500 Ω
Allowable wire resistance	RTD: ≤ 10 Ω per wire
Input value correction	<ul style="list-style-type: none"> User adjustment: ±50%FS both for zero point and span point Square-root extractor: OFF or cut point from 0.0 to 125.0% First-order lag filter: 0.0 to 900.0 s Linearizer: Makes a line chart in which 16 data points are connected by straight lines
Noise reduction ratio	<ul style="list-style-type: none"> Normal mode: 40 dB (50/60 Hz) Common mode: 120 dB (50/60 Hz)

Display and keys

Type	LED
Keys	9 keys
Cotents	PV: 7-segment, 5-digit SV/MV: 7-segment, 5-digit Parameter number: 7-segment, 2-digit Bar graph: 12-segment Status indicator: standby, control output, alarm, control mode

Structure

Installation	Panel mounting
Electrical connection	M3 screw terminal
Case	Plastic, gray
IP rating	Equivalent to IP66 and NEMA 4X
Weight	Approx. 500 g

PV input

No. of inputs	1 or 2
Signal	Thermocouples, RTD, voltage, or current *See a separate table for measurement range.
Sampling rate	50 ms
Indication accuracy (at 23°C)	<ul style="list-style-type: none"> Thermocouple: (±0.1%FS ±1digit ±1°C) or ±1.5°C, whichever is larger Thermocouple B, 0–400°C range: ±5%FS ±1digit ±1°C Thermocouple R, 0–500°C range: ±1%FS ±1digit ±1°C RTD: (±0.1% FS ±1digit) or 0.25°C, whichever is larger Voltage, current: ±0.1%FS ±1digit
Burnout	In the thermocouple input version or the RTD input version, a user can select either the upper or the lower limit to which the control output should go when a sensor burnout occurs.

Digital input

No. of inputs	4 to 9
Switch	Volt-free contact or transistor
Contact capacity	12 V DC, about 2 mA (per point)
Input pulse width	≥ 200 ms
Functions	Control mode changeover, EX-MV selection, SV changeover, Control standby, Auto-tuning start, Timer start, Alarm latch cancel

Analog input (option)

No. of inputs	1
Signal	<ul style="list-style-type: none"> DC voltage: 1–5 V DC, 0–5 V DC, 0–10 V DC Valve position feedback signal (potentiometer): resistance range: 100Ω to 10KΩ, 3-wire

Control output

	Control output 1	Control output 2 (for heating and cooling control)
No. of points	1	1
Type	select one among four. <ul style="list-style-type: none"> Relay contact output: SPDT contact (DO4) SSR/SSC driving output: Rating: 12 V DC (10–15 V DC) 4–20 mA DC Motor-operated valve operation pulse output (open–close output): SPST-NO contact × 2 (with interlock circuit) 	select one among three. <ul style="list-style-type: none"> Relay contact output: SPST-NO (DO3) SSR/SSC driving output: Rating: 12 V DC (10–15 V DC) 4–20 mA DC

Control

Control type	Two-degree-of-freedom PID	
Control mode	Auto/manual/remote (changeover is available by key operation, digital input, or communication)	
Control template	allows a user to switch among the operation block and the I/O settings.	
Parameters	(Basic control type and valve control type)	(Heating and cooling control type)
Proportional band (P)	0.0 to 999.9%, ON/OFF (2-position) operation at P = 0	0.0 to 999.9%
Integration time (I)	0.0 to 3200.0 s, Integral operation OFF at I = 0	0.0 to 3200.0 s, Integral operation OFF at I = 0
Differential time (D)	0.0 to 999.9 s, Derivative operation OFF at D = 0	0.0 to 999.9 s, Derivative operation OFF at D = 0
Proportional cycle	1 to 150 s, For SSR/SSC drive or relay output only	1 to 150 s, For SSR/SSC drive or relay output only
Control cycle	50 ms	50 ms
Anti-reset windup	0 to 100% of measurement range	0 to 100% of measurement range
Hysteresis band	50% of measurement range, for on-off control only	50% of measurement range, for on-off control only
Number of SV and PID patterns	7	7

Alarm

No. of alarms	≤ 8
Alarm type	PV (H/L limit, absolute/deviation, band), PV variation ratio, SV H/L limit, device error
Alarm ON-delay	0 to 9999 s, 0 to 9999 min

Digital output

No. of outputs	2 (DO3 & DO4) to 9
Contact	<ul style="list-style-type: none"> SPST-NO contact (except for DO4) SPDT contact (DO4) Contact capacity: 220 V AC / 30 V DC, 1A (resistive load) Contact life: 100,000 operations (rated load)
Functions	Alarm, timer, control output (DO4)

Transfer output

No. of points	≤ 2
Type	4–20 mA
Contents	PV, SV, MV, DV, AIM, MVRB, TV

Power supply output for transmitter

No. of outputs	1
Rating	24 V DC (17–30 V DC)

RS-485 communication

Modbus RTU, two-wire, half-duplex bit serial, asynchronous communication	
Serial characteristics	Data bits: 8 bits. Parity: odd, even, none Baud rate: 9600 bps, 19200 bps, 38400 bps
Connection	≤ 32 units
Communication distance	≤ 500 m (total connection length)

Other functions

Ramp soak	64 step ramp soak with guaranteed soak
Data backup at power outage	on non-volatile memory
Self-diagnosis	by watchdog timer
Math function	Temperature and pressure compensation, average, H/L selector, input switching, etc.

Operation and storage conditions

Operating temperature	-10°C to +50°C
Storage temperature	-20°C to +60°C
Humidity	≤ 90% RH (no condensation)

Ordering Code

Basic Type

P X H 4 5 6 7 8 9 10 11 12 13
9 A 1 - V 0

Digit	Specification	Code
4	<Front dimensions> 96 x 96 mm	9
5	<Number of control loops/Function> 1-loop basic controller	A
6	<PV input> 1 point 2 points*1	1 2
7	<Analog input> None DC voltage: 1 point	0 1
8	<Revision code>	1
9	<Output>*3 OUT1 OUT2	
	Current	1
	Current	2
	Current	5
	SSR/SSC driver	A
	SSR/SSC driver	B
	None	Transmitter supply
10	<Power supply> 100 to 240 V AC	V
11	<Communication interface> None RS-485	0 R
12	<Digital input and output>*1,2 DI DO	
	4	2
	4	4
	9	9
13	<Additional specifications> None	0

- *1:The 6th code "2" (2 inputs) and the 12th code "B" (9 DI and 9 DO) are not compatible.
*2:When you use a relay for the control output 1, the terminal DO4 is allocated to it.
*3:See the matrix on the right side for the function of each output.

Code	9th digit	Terminal	DO4	OUT1	OUT2		
		Output Kind	Relay	Current (4 to 20 mA)	SSR/SSC driver	Current (4 to 20 mA)	Transmitter power supply
		Function*	Control output or Digital output	Control output or Transfer output	Control output	Transfer output	Transmitter power supply
	1	✓	✓				
	2	✓	✓		✓		
	5	✓	✓				✓
	A	✓		✓			
	B	✓		✓	✓		

* If there are two functions listed, a user can select the function by parameter setting.

Heating/Cooling Control Type

P X H 4 5 6 7 8 9 10 11 12 13
9 F 1 - V 0

Digit	Specification	Code
4	<Front dimensions> 96 x 96 mm	9
5	<Number of control loops/Function> 1-loop heating/cooling controller	F
6	<PV input> 1 point 2 points*1	1 2
7	<Analog input> None DC voltage: 1 point	0 1
8	<Revision code>	1
9	<Output>*3 OUT1 OUT2	
	Current	1
	Current	2
	Current	3
	Current	5
	SSR/SSC driver	A
	SSR/SSC driver	B
	SSR/SSC driver	C
10	<Power supply> 100 to 240 V AC	V
11	<Communication interface> None RS-485	0 R
12	<Digital input and output>*1,2 DI DO	
	4	2
	4	4
	9	9
13	<Additional specifications> None	0

- *1:The 6th code "2" (2 inputs) and the 12th code "B" (9 DI and 9 DO) are not compatible.
*2:When you use one relay for the control output, the terminal DO4 is allocated to it. When you use two relays for the control output 1 and the control output 2, the terminal DO3 and DO4 are allocated respectively.
*3:See the matrix on the right side for the function of each output.

Scope of delivery

Controller, mounting bracket, watertight packing, unit label, terminating resistor (for version with RS-485 communication only), instruction manual

Motorized Valve Control Type

P X H 4 5 6 7 8 9 10 11 12 13
9 1 - V 0

Digit	Specification	Code
4	<Front dimensions> 96 x 96 mm	9
5	<Number of control loops/Function> 1-loop motorized valve controller (with valve position feedback input) 1-loop motorized valve controller (without valve position feedback input)	D S
6	<PV input> 1 point 2 points*1	1 2
7	<Analog input> None DC voltage: 1 point	0 1
8	<Revision code>	1
9	<Output>*2 OUT1 OUT2	
	Current	1
	Current	2
	Current	5
	None	Transmitter supply
10	<Power supply> 100 to 240 V AC	V
11	<Communication interface> None RS-485	0 R
12	<Digital input and output>*1,3 DI DO	
	4	2
	4	4
	9	9
13	<Additional specifications> None	0

- *1:The 6th code "2" (2 inputs) and the 12th code "B" (9 DI and 9 DO) are not compatible. Select "2 points" when a remote SV input (RSV) is required.
*2:"D" for the 5th digit and "1" for the 7th digit cannot be specified at the same time.
*3:DO4 is used as control output. If 2 or 3 DO points are required for event output, specify the code A, and if 4 to 8 DO points are required, specify the code B.

Code	9th digit	Terminal	DO4	OUT1	OUT2	
		Output Kind	Relay	Current (4 to 20 mA)	Current (4 to 20 mA)	Transmitter power supply
		Function*	Valve control output	Transfer output	Transfer output	Transmitter power supply
	1	✓	✓	✓		
	2	✓	✓	✓	✓	
	5	✓	✓	✓		✓

* If there are two functions listed, a user can select the function by parameter setting.

Code	9th digit	Terminal	DO3	DO4	OUT1	OUT2			
		Output Kind	Relay	Relay	Current (4 to 20 mA)	SSR/SSC driver	Current (4 to 20 mA)	SSR/SSC driver	Transmitter power supply
		Function*	Control output or Digital output	Control output or Digital output	Control output or Transfer output	Control output	Control output or Transfer output	Control output	Transmitter power supply
	1	✓	✓	✓	✓				
	2	✓	✓	✓	✓		✓		
	3	✓	✓	✓	✓			✓	
	5	✓	✓	✓	✓				✓
	A	✓	✓	✓	✓	✓			
	B	✓	✓	✓	✓	✓	✓		
	C	✓	✓	✓	✓	✓	✓		

* If there are two functions listed, a user can select the function by parameter setting.

Measurement range

	Input signal	Range [°C]		Resolution (°C)	
		Max.	Min.		
RTD	Pt100	-150 to 850	0 to 150	0.01	
	Thermocouple	J	0 to 1000	0 to 400	0.1
		K	0 to 1200	0 to 400	0.1
		R	0 to 1600	0 to 1600	0.1
		B	0 to 1800	0 to 1800	0.1
		S	0 to 1600	0 to 1600	0.1
		T	-200 to 400	-200 to 200	0.1
		E	-200 to 800	0 to 800	0.1
		PR40/20	0 to 1800	0 to 1800	0.1
		Ni	0 to 1300	0 to 1300	0.1
		PL-II	0 to 1300	0 to 1300	0.1
	DC voltage	WR5-26	0 to 2300	0 to 2300	0.1
		1 to 5 V 0 to 5 V 0 to 10 V 0 to 10 mV 0 to 50 mV	-19999 to 99999 (Range where scaling is allowed)		1/10000 digit
4 to 20 mA 0 to 20 mA					
Motorized valve position feedback	Potentiometer	100 to 10 k		1/1000 digit	

Separate order items

Terminal cover	ZZP PXR1-B230	Two pieces are necessary per unit.
PC loader interface cable	ZZP PXH1*TK4H4563	For RS-232C Interface

Multi-Loop Module Type Temperature Controller

PUM



30 x 100 x 85 mm



- Control Module
- Event Input/Output
- Analog Input/Output
- Analog Input
- Analog Output
- CC-LINK
- Programless Communication with Mitsubishi PLC
- PROFIBUS
- Ethernet

Smart!

- Up to 64 loops (4 loops x 16 units)
- Heater break alarm by using CT, up to 8 points
- Communication with PLC

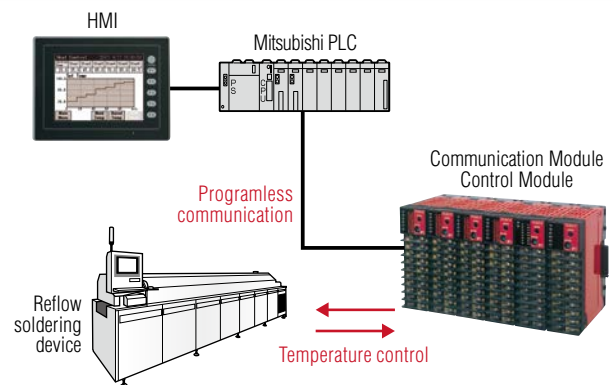

Easy!

- Detachable terminal
- Easy-to-use software
- Easy mounting onto DIN rail





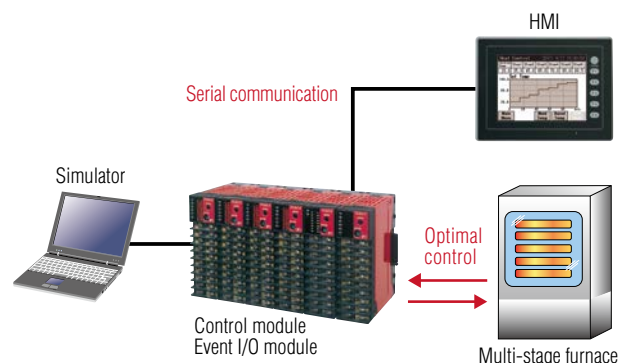



Fast!

- High-speed data transmission (RS-485 / 115.2 kbps or 230.4 kbps)
- Sampling time: 200 ms



PUM

Variations

Temperature control	Control Module	PUMA PUMB		Communication	CC-LINK	PUMCL		Analog input/output	Analog I/O Module	PUMV	
	2 ch or 4 ch 8 CT inputs				Communication speed 10 Mbps				4 AIs and 4 AOs Transfer output		
	Digital input/output	Event I/O Module	PUME			Programless Communication with Mitsubishi PLC	PUMCM			Analog Input Module	PUMN
8 DIs & 8 DOs				Direct address mapping			4 AIs Remote input				
Communication	Ethernet	PUMCE		PROFIBUS	PUMCP		Analog Output Module	PUMT			
	10BASE-T 100BASE-TX			PROFIBUS DP-V0 Communication speed 12 Mbps			4 AOs Transfer output				

System Configuration Example

- Control module (PUMA, PUMB) + analog I/O module (PUMV, PUMN, PUMT): up to 16 units in total
- Event I/O module (PUME): up to 16 units

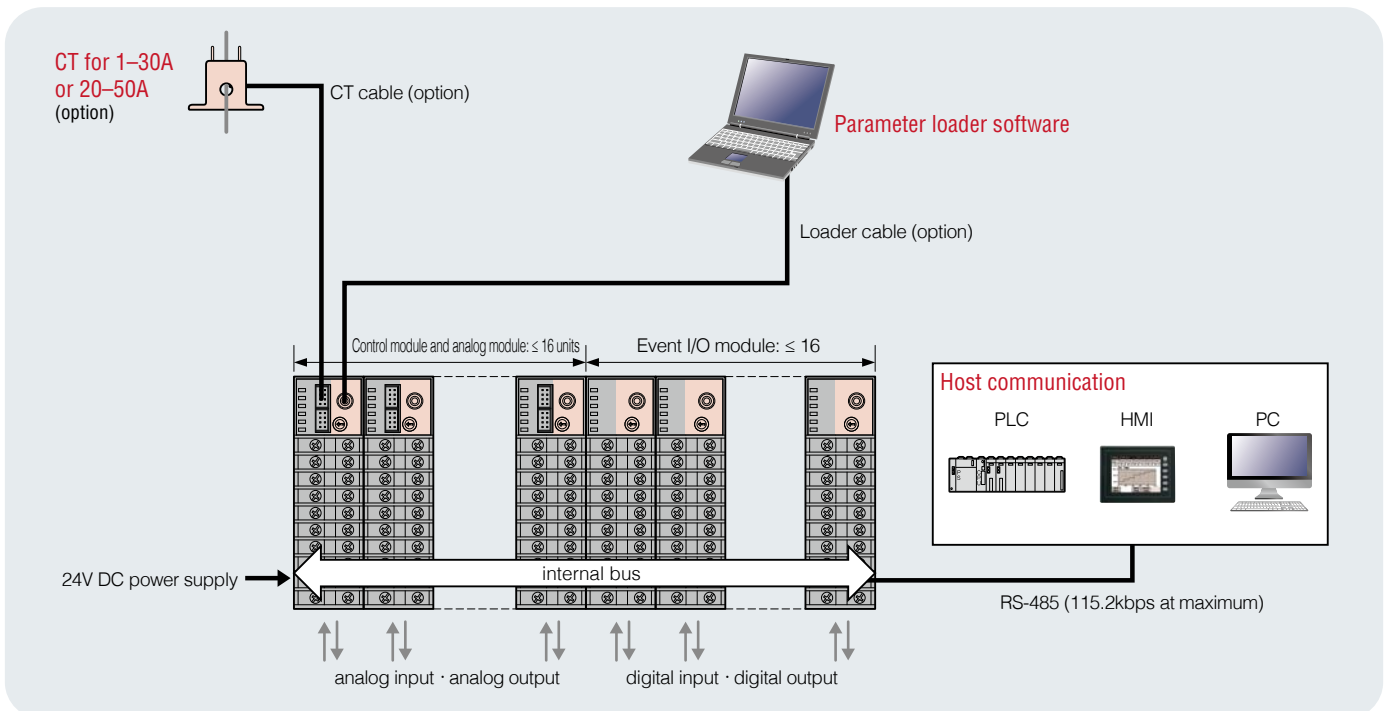

Digital Thermostat

PXR3



48 × 24 × 98 mm



Temperature Alarm with On-Off Contact Output Ideal for Overheat Detection

- Thermocouple input or thermistor input
- Waterproof front panel: IP66 and NEMA 4X equivalent
- Up to two alarm outputs (H, L, HH, LL alarm available)
- Alarm setting in 1°C steps
- Panel mounting
- DIN rail mounting or wall mounting with optional adapter
- Lightweight 150 g
- Simple operation with three front keys
- European-style terminal

PXR3

Specifications

Power supply voltage	100 (-15%) V to 240 (+10%) V AC, 50/60 Hz Power consumption: ≤ 6 VA (at 100 V AC), ≤ 8 VA (at 240 V AC),
Input	Number of inputs: 1 Input signal and measurable range: see Table 1. Allowable signal source resistance: thermocouple input $\leq 100\Omega$ Measurement cycle: ≤ 2 seconds Burnout function (open-circuit detection): you can set the output upon an open-circuit to the upper limit or the lower limit Input impedance: thermocouple input ≥ 1 M Ω Input filter: first-order lag filter, configurable in 0.5-second steps, within 0–90 seconds Input compensation: configurable within $\pm 10\%$ of measurement range
Display and keys	Green LED 7-segment 4-digit alphanumeric display Display contents: measured value, alarm 1 setpoint, alarm 2 setpoint, parameter name, parameter value 3 keys, with key lock function
Accuracy	Indication accuracy: See Table 1 (Error of temperature sensor is not included) Reference junction compensation accuracy: $\pm 1^\circ\text{C}$ (at 23 $^\circ\text{C}$)
Alarm output	SPST-NO contact, 1 or 2 points Contact capacity: 220 V AC / 30 V DC, 1A (resistive load) Mechanical life of contact: 10 million times (no load) Electrical life of contact: 100 thousand times (rated load) Output cycle: 0.5 seconds Alarm type: (high or low absolute alarm, hold function available) Alarm setpoint: configurable in 1 $^\circ\text{C}$ steps, within 0–100% of measurement range Hysteresis: configurable in 1 $^\circ\text{C}$ steps, within 0–110% of measurement range Alarm delay: configurable within 0–120 seconds
Operating conditions	Ambient temperature: -10 $^\circ\text{C}$ to +50 $^\circ\text{C}$ Ambient humidity: $\leq 90\%$ RH (no condensation)
Installation	Panel mount, or DIN rail or wall mount when using DIN rail mounting adapter (separate order item)
Electrical connection	European-style terminal
Case	Plastic (equivalent to non-combustibility grade UL94V-0), black
IP rating of front panel	IP66 (equivalent to NEMA 4X) When installed with our genuine waterproof packing.
Weight	Approx. 150 g

Measurement range

Sensor	Range ($^\circ\text{C}$)	Indication accuracy
Thermocouple	J	0 to 800 $\pm 0.5\%$ FS ± 1 digit $\pm 1^\circ\text{C}$
	K	0 to 1200 $\pm 0.5\%$ FS ± 1 digit $\pm 1^\circ\text{C}$
	R	0 to 1600 $\pm 0.5\%$ FS ± 1 digit $\pm 1^\circ\text{C}$
	T	0 to 400 $\pm 0.5\%$ FS ± 1 digit $\pm 1^\circ\text{C}$
	E	0 to 600 $\pm 0.5\%$ FS ± 1 digit $\pm 1^\circ\text{C}$
Thermistor	PB-36	0 to 100 $\pm 4^\circ\text{C}$

Notes:

- The thermostat cannot deliver the accurate indication when the sensor is the type R thermocouple and the temperature is in the range between 0 and 500 $^\circ\text{C}$.
- You cannot switch the input type between the thermistor and the thermocouple. You can switch the input type among the five type of thermocouples by using the front keys.
- If you change the input type, be sure to change the measurement range setting accordingly.
- The indication accuracy of thermocouple does not include the reference junction compensation error ($\pm 1^\circ\text{C}$).
- The indication accuracy of thermistor does not include the error of sensor.

Ordering code

Sensor		Number of alarms	Model code
Thermocouple	Not provided	1	PXR3TAY2-0V061
		2	PXR3TAY2-1V061
Thermistor	Provided	1	PXR3HAY2-0V061
		2	PXR3HAY2-1V061

Scope of delivery

Thermostat, panel-mounting adapter, front waterproof packing, instruction manual
*For the thermistor input version, a thermistor sensor is additionally provided.

Separate order item

DIN rail adapter	ZZP*CTK368715P1
------------------	-----------------

Default setting

Measurement range	Type K thermocouple: 0 $^\circ\text{C}$ to 1200 $^\circ\text{C}$ Thermistor: 0 $^\circ\text{C}$ to 100 $^\circ\text{C}$
Alarm setpoint	Type K thermocouple, 1 alarm: upper limit 1200 $^\circ\text{C}$ Type K thermocouple, 2 alarms: lower limit 0 $^\circ\text{C}$, upper limit 1200 $^\circ\text{C}$ Thermistor, 1 alarm: upper limit 100 $^\circ\text{C}$ Thermistor, 2 alarms: lower limit 0 $^\circ\text{C}$, upper limit 100 $^\circ\text{C}$
Alarm hysteresis width	1 $^\circ\text{C}$
Alarm delay time	0 seconds
Indication	Measured value
Burnout	Upper limit
Input filter	5 seconds
Input value compensation	0%

Attached thermistor sensor

Measurement range	0 $^\circ\text{C}$ to 100 $^\circ\text{C}$
Constant β	3990 K
Nominal resistance	6 k Ω ($^\circ\text{C}$)
Lead wire	Heat-resistant vinyl chloride, black, 520 mm, Temperature range: -20 $^\circ\text{C}$ to +105 $^\circ\text{C}$
Accuracy	$\leq 2^\circ\text{C}$

Dimensions (unit: mm)

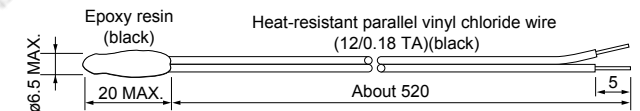

Thermistor sensor for replacement

ZZP*CTK7L3941P1

Please read the following instructions carefully before operating the Digital Temperature Controller

⚠ WARNING **Over-Temperature Protection**

Any control system design should take into account that any part of the system has the potential to fail.

For temperature control systems, continued heating should be considered the most dangerous condition, and the machine should be designed to automatically stop heating if unregulated due to the failure of the control unit or for any other reason.

The following are the most likely causes of unwanted continued heating:

- 1) Controller failure with heating output constantly on
- 2) Disengagement of the temperature sensor from the system
- 3) A short circuit in the thermocouple wiring
- 4) A valve or switch contact point outside the system is locked to keep the heat switched on.

In any application where physical injury or destruction of equipment might occur, we recommend the installation of independent safety equipment, with a separate temperature sensor, to disable the heating circuit in case of overheating.

The controller alarm signal is not designed to function as a protective measure in case of controller failure.

Information in this catalog is subject to change without notice.
Read the instruction manuals thoroughly before using the products.

 Fuji Electric Co., Ltd.

www.fujielectric.com

Instrumentation & Sensors Planning Dept.

Gate City Ohsaki, East Tower, 11-2, Osaki 1-chome, Shinagawa-ku, Tokyo 141-0032, Japan

Phone: +81-3-5435-7021 Fax: +81-3-5435-7475

www.fujielectric.com/products/instruments/